

BODIES BUILT BETTER



BUILT IN THE U.S.A.



1967-69 CHEVY  
CAMARO BODY



1967-69 CHEVY  
CAMARO RACE BODY



1970-81 CHEVY  
CAMARO BODY



1970-81 PONTIAC  
FIREBIRD BODY



1962-67 CHEVY II  
NOVA BODY



1962-67 CHEVY II  
NOVA RACE BODY



1955-57 CHEVY SEDAN  
& HARDTOP BODY



1955-57 CHEVY  
CONVERTIBLE BODY

# STEEL BODY, PARTS & ACCESSORIES CATALOG

[www.realdealsteel.com](http://www.realdealsteel.com)

407-585-1957



# THE DIFFERENCE IS IN THE DETAILS

*Enthusiast - Owned Real Deal Steel Builds New Steel Bodies in the United States.*

Real Deal Steel is at the forefront of the development and production of steel reproduction bodies for classic American muscle cars. We are proud to assemble the finest quality steel bodies in the business for nearly a decade. We have assembled & delivered over 1,000 steel bodies since we began!

RDS 1955 Sedan Built for CPP's Week-to-Wicked with Super Chevy



Like the steel panels that we use, our bodies are assembled to the highest quality standards, with the restoration industry's best fitment and body gaps. Our bodies are available as a skeleton, complete body or complete body with front end sheet metal package. Our bodies can be seen throughout the world in restoration, custom and race builds.

At our state-of-the-art production facility in Sanford, FL, we assemble Tri-Five Chevy, Chevy II Nova, Camaro and Firebird bodies everyday on one of five different assembly stations. We work closely with our sheet metal manufacturers to assure the finest quality and best fitting panels that are designed to work hand-in-hand with your OEM panels.

## How We Build a Body

Each body starts with a body-specific steel platform mounted to a heavy-duty rotisserie on which the floor assembly is built. From there we assemble our custom fixtures that include numerous cam-locks & mounting points that fit into factory tooling holes. Our fixtures are hand crafted with years of refinement and adjustments for the best body every time. The fixtures are originally built inside of several original bodies and periodically test-fit in different original bodies for fitment checking. Our steel panels are then carefully assembled and fit around our fixtures thus duplicating the original specifications. We use 220-V water-cooled spot welders for factory-appearing welds, and we add more welds than original cars for added strength and rigidity.



All panels used on our bodies are also sold separately. We only use the latest tooling and molds for the best products available. Many panels available in the marketplace have more than one set of tooling. Some tools can be decades old, so be sure you are buying the latest, best-fitting panels available today. There are other manufacturers that offer steel bodies, but we are proud to say that NOBODY else works directly with the parts manufacturers and uses the factory-assembly techniques that we do!

Our steel bodies are shipped around the world to builders or car owners for a full restoration build, many using original donor parts with our bodies. Many have gone on to become award winning show cars, with some being used to build world-class race cars, including road race and drag race cars. Several have sold for over \$200,000!



# THE PROCESS. BUILT BETTER.

Not all bodies are built the same. Real Deal Steel uses a solid heavy steel foundation that mimics the factory chassis. We start each build on this solid platform for a consistent fit. We then assemble each body around our custom jig that has all of the factory mounting points — Fitting into original panel tooling holes.

Our welding process is also crucial to the building process. Our water cooled resistance spot welders provide a solid weld with a factory-like finish. We actually use more welds than an original car. This adds strength to each body we build. Each jig has been painstakingly built to factory specs for a consistent fit.



**Precision Fit. Welded Strength. Factory Fit and Finish. State of the Art Jigs.**



**Highest Quality Panels. Experienced Craftsman.**



## CATALOG INDEX

Tri-Five Bodies.....	8	Tri-Five Lighting .....	28
Tri-Five Chassis.....	9	Tri-Five Window .....	29
Tri-Five Bumpers .....	10	Tri-Five Engine .....	30
Tri-Five Front End.....	11	Tri-Five Brake/Susp.....	31
Tri-Five Cowl/Firewall.....	12	Tri-Five Interior.....	32
Tri-Five Fenders.....	13	Tri-Five Gauges.....	33
Tri-Five Roof.....	14	Tri-Five Heater .....	34
Tri-Five Convertible.....	15	Tri-Five Int Molding.....	35
Tri-Five Hoods.....	16	Tri-Five Body Shimming.....	36
Tri-Five Doors.....	17	Chevy-II/Nova Bodies.....	37
Tri-Five Rocker Panels.....	18	Chevy-II/Nova Metal.....	38
Tri-Five Floor Pans.....	19	Chevy-II/Nova Metal.....	39
Tri-Five Package Tray.....	20	Camaro/Firebird Bodies	40
Tri-Five Quarter Panels .....	21	Camaro Front End.....	41
Tri-Five Trunk.....	22	Camaro Hood & Cowl.....	42
Tri-Five Tailgate.....	23	Camaro Roof & Fender.....	43
Tri-Five Ext Molding.....	24	Camaro Door & Floor.....	44
Tri-Five Molding/Glass.....	25	Camaro Quarter Panel .....	45
Tri-Five Windshield .....	26	Camaro Trunk .....	46
Tri-Five Vent/Side Glass.....	27	1949-54 Chevy.....	46-47

**Custom Options. Worldwide Delivery.**



# WHEN SHOULD I BUY A REAL DEAL STEEL BODY?



*It is often difficult to decide how to progress with your project car. When you or the shop has stripped the car down and perhaps sent the body and parts out for media blast or dipping, the results can be shocking! What was once a car that needed a few patches now has major rust holes in every panel.*

The quotation from the shop for the panels and labor just to get the body into shape so final bodywork can be done may often exceed the cost of a new body. If that occurs, it is time to consider a new RDS body. If the shop indicates that the car only needs floors, trunk floor, rockers and a quarter panel - then keeping and building your original body may be best. Consider cost, time frame (many shops will take YEARS to complete - or may never complete a BIG rustoration project), the quality car you want (driver or high-end), and of course, emotion.

Some enthusiasts have the car that they owned when they were 16, or it's been in the family since new...and they want THAT car. Be aware that you may spend far more building the rusty car, but only you know if you will be happy with a "new" body verses the repaired original.

## *Does a Replacement Body Affect the Value?*

We are often asked "Will the car built using the new RDS body be worth less than my original restored body?" There is no always - true answer, but consider the potential purchaser of your finished car. They want to purchase a car that is clean, fits well, drives well, appeals to them visually and comfort-wise - and most importantly, one that will last. They don't want to deal with rust bubbles or cracks in body work or poor appearance due to major patches & repairs. That said, the restoration featuring our reproduction body vs. a rusty patch-job will often have more value.

# ARE REAL DEAL STEEL'S PARTS PERFECT?

*No. While we carry the best reproduction sheet metal parts available, many times it is the ONLY part available. We work with several large manufacturers and help them produce new parts as well as improve existing parts. Many times, the part is so complex and the tooling so difficult and expensive to make, that there may be flaws or shortcomings in the final part. So why not just have the manufacturer "fix" the issues? Manufacturer corrections can be easy (changing trim dies, moving laser cut hole locations, using proper gauge steel), yet other times it is difficult or impossible due to the expense of the tooling and the low sales volume of the part.*

Since we are enthusiasts like you, we work on our own cars. Plus, we have built thousands of new steel bodies using the very same parts we sell. We have learned how obtain the best results when using these parts with flaws, when no alternative is available, and are more than happy to share information on the flaws and remedies where possible. **These items are marked with a + following the description in the catalog. To review the flaws and remedies visit [realdealsteel.com](http://realdealsteel.com) and enter the SKU into the search box. When viewing the item, there will be a final bullet point labeled "Challenges".**

**There you can view our assessment of the shortcomings & flaws along with our suggested remedies.**



Why do we tell you this when no one else does? We would much rather you elect NOT to purchase an item from us than to purchase it and be completely unhappy. If you are unhappy with an item, it costs you to return it and it costs us our reputation in the marketplace. If you know in advance that an item likely has issues that will need to be corrected by you or your installer to make an excellent repair on your vehicle, then we have done our job by letting you know exactly what to expect before you decide to purchase the item.

Be aware that the very same part where we may be pointing out the "challenges" to you, other suppliers may be more than willing to sell you that same part and call it "perfect". Why do they do this? Other than being primarily interested in making the sale, there is nearly a 100% chance they have never installed the part on a car. Chances are they have never even seen the part - they are simply a reseller and not an enthusiast. Once you receive any item from us, we are happy to answer any fitment or installation questions you or your installer may have. We have installed each and every part we sell!

# ARE REAL DEAL STEEL'S BODIES PERFECT?

No. Even with our precise fixtures & assembly techniques, every body we produce will have flaws. Often, the flaws are the fault of the parts we use, sometimes the flaws are created in the process of assembly. We advise customers that most bodies will require 60-80 hours of final metal finishing, fitting & filler before they are ready for final primer.

What are the flaws? We do not add any fillers or seam sealers to our new-steel bodies. That way, when you receive yours, what you see is what you get – nothing is hidden. Factory seams that were filled with lead will be raw welded seams on a Real Deal Steel body. Those seams include: cowl to A-pillar, A-pillar to top skin, rocker to quarter panel, C-pillar to top skin, quarter panel to rear deck filler, outer quarter panel to trunk panels, tailpanel to trunk panel. These areas are best filled not with lead, but with modern waterproof heavy strand fillers like SEM Carbo-Fill then final finished with high-quality lightweight body filler.



We recommend fitting ALL of your exterior trim to the body before completing the final bodywork. This does not always mean securing with clips and fasteners – just place them on the body (particularly windshield and rear glass trim) to make certain everything fits properly before final paint. Areas where glass trim is installed is often near seams that must be filled, and too much or too little filler can create unsightly gaps between the body and the trim.



We recommend placing the body on the frame (1955-57 Chevy only) and installing all body bolts and shims before test fitting front end sheet metal and final fitting doors and deck lids. The frame should be on all four wheels and tires or at least supported to simulate all four wheels and tires. Even when bolted securely to the frame, the bodies can flex wildly depending on where a jack is placed. Poor alignment and impossible gaps are often easily adjusted by adding or subtracting shims at specified points per the **GM Shimming and Adjustments Guide shown on realdealsteel.com**. Click on "News" and scroll down to **1955-57 Chevy Body Fit & Adjustments for the complete guide**.

For cars with front subframes, these should be installed and aligned before front end sheet metal is fitted. Don't expect that your reproduction or used or NOS sheet metal is going to fit perfectly. Adjusting, bending, even cutting & welding can be required to obtain show-car gaps. **Go to realdealsteel.com, click on "News" & scroll down to Real Deal Steel NMCA '69 Camaro RS/SS Quick Build for some tips & what to expect.**

The Real Deal Steel assembly factory will often cut and slightly modify a panel, re-weld and metal finish to obtain a satisfactory door or trunk gap when assembling our new bodies. These areas will require final metal finishing and filler before final primer and paint can be applied.

Why do we tell you this? We want you to be 100% happy with your new steel body purchase. The decision to purchase a reproduction body is an expensive one and should not be taken lightly. We want you and your body man to be aware that additional fit, finish and bodywork will be required before the body is ready to paint and assemble!



*Real Deal Steel Builds All New Steel Bodies in the United States.*



# SHIPPING & RETURNS

## WHAT SHIPPING OPTIONS ARE AVAILABLE?

Online orders will be shipped via Fedex Ground, Fedex Express, UPS, USPS or Truck Freight. For all Truck Freight shipments, please provide a commercial (business) ship-to address for optimal service. We do not ship to P.O. boxes.

## IS THERE A COST ON RETURNS?

If an item needs to be returned the shipping fees are the customer's responsibility. All returned items must be in as-new condition with original packaging. Primed, painted, cut or installed items cannot be returned. Items not in the original box cannot be returned. All returns are subject to a 20% restocking fee.

## WHAT IF AN ITEM IS OUT OF STOCK?

Items not in stock at the time of your order will be placed on backorder. You will be notified immediately via email if an item is out of stock and you will be advised of the expected ship date.

## DO YOU SHIP OUTSIDE OF THE USA?

We ship anywhere in the continental USA plus Alaska and Hawaii. We are happy to ship large or freight orders outside the USA to your shipping consolidator, agent, broker or border representative. Small items will ship USPS International Priority.

## HOW DO WE SHIP OVERSEAS?

**For items that do not need to ship via truck freight, we are happy to list specific items you wish to order on eBay plus a 10% premium to take advantage of eBay's discounted Global Shipping Program! You simply complete the purchase and eBay handles the shipping to any country outside the USA.** We can often ship small parts out of the Continental USA using USPS or DHL. For larger items/orders and car bodies, we have compiled a list of US-based freight companies that have the ability to export to you (or ship to AK and HI) via ocean or air. Feel free to contact any/all of these companies for quotes to your door. The freight company can arrange pick up at our location (1220 East 30th Street, Sanford, FL 32773 USA) or we can ship your order to their US location at our ground shipping rates for export to you. Address any questions to [info@realdealsteel.com](mailto:info@realdealsteel.com).

## LARGER ITEMS

For shipping outside the lower 48, contact:

### CALIFORNIA SHIPPING: 714-590-1999

11121 Dale St, Stanton, CA 90680 | [www.calship.com](http://www.calship.com) | [sales@calship.com](mailto:sales@calship.com)

### INTEGRATED LOGISTICS MANAGEMENT CORP: 949-305-8500

16200 Scientific Way, Irvine, CA 92618 | [www.ilmcorp.net](http://www.ilmcorp.net) | [sales@ilmcorp.net](mailto:sales@ilmcorp.net)

### SEA CARGO, INC.: 562-435-8788

235 E Broadway #1020, Long Beach, CA 90802  
[www.seacargoinc.com](http://www.seacargoinc.com) | [Kevin.Burgess@seacargoinc.com](mailto:Kevin.Burgess@seacargoinc.com)

### INTERMODAL MANAGEMENT SYSTEM, LLC: 732-935-8400

265 Industrial Way West Ste 1, Eatontown, NJ 07724  
[www.imstransport.com](http://www.imstransport.com) | [rates@imstransport.com](mailto:rates@imstransport.com)

### TRANATLANTIC SHIPPING CORP: 561-480-1544

West Palm Beach, FL  
[www.transatlanticshippingcorp.com](http://www.transatlanticshippingcorp.com) | [yasmin@transatlanticshippingcorp.com](mailto:yasmin@transatlanticshippingcorp.com)

### UNIWORLD INTL. INC.: 407-264-0000

8150 Chancellor Drive, Suite 105, Orlando, FL 32809 | [TheoV@Shipall.com](mailto:TheoV@Shipall.com)

### PEMBROKE MARINE SERVICES INC: 908-862-2262

2416, 975 E Linden Ave, Linden, NJ 07036 | [sales@shippingmycar.com](mailto:sales@shippingmycar.com)



## HOW DO I TITLE AND REGISTER A CAR BUILT USING A REAL DEAL STEEL BODY?

Get the fact sheet from your local DMV or your state DMV website.

Document all build sales & receipts.

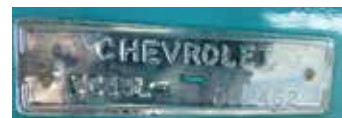

If you do not have a new or original chassis with a title or MSO, you will need to register the car built with a Real Deal Steel body as a "Newly Assembled" vehicle with your state. While we do not issue an MSO, you will be issued a Bill of Sale (your purchase invoice) by the dealer you purchased your body from. This invoice will be considered as an MSO by your state DMV (check your local laws and regulations). You can find state specific information by visiting the SEMA Action Network's page: You can find the link to your state on our website where the Florida license plate is at the top of the homepage.

**BEFORE YOU START** — Know what kind of documentation that the state is going to require for issuing title. Get fact sheets from your state's Department of Motor Vehicles. Read them carefully, and keep all of that information in mind as you buy your parts and build your car. Major parts like engines, transmissions and frames make sure you get adequate proof of purchase documentation. For major components like engines, make sure the bill has the VIN or serial number on it. Keep all bills of sale, invoices, & even canceled checks, credit card receipts or statements. For example: a bill of sale should have the vendor's name and address, your name, a description of the part, and the amount and date of purchase.

From the very first part you buy keep a build diary. Things like major component disassembly/assembly, sanding/blasting, painting, etc. should be recorded. VIN and serial numbers should be documented by photographs or rubbings, or both.

Find more tips on our website: [www.realdealsteel.com](http://www.realdealsteel.com)

Errors in typographical content, pricing and photography are subject to correction and may change without notice.



**WARNING:** This product can expose you to chemicals which are known to the state of California to cause cancer and birth defects or other reproductive harm. More info @ [www.P65Warnings.ca.gov](http://www.P65Warnings.ca.gov)



# TIPS FROM THE GARAGE

## Fit and Trim

Any time a windshield, back glass or trim opening is disturbed with the installation of a new panel, use your trim pieces as a guide to move everything into the right place. New panels may need to be cut & re-shaped to fit your original or reproduction trim. Doing this when the panels are being installed is much better than waiting to test fit after the car is painted!



## Do the Twist

Original and reproduction doors alike can be tough to fit to the door openings. Even after adjusting the hinges to the body and the door to the hinges, the doors still may not fit. A common issue is the door hanging out past the quarter panel at the top or the bottom. Fixing this on reproduction doors is quite easy. Cut a small block of wood, place it between the door and the body at the top or bottom and attach a cheap ratchet strap at the bottom or top (opposite the block of wood) and ratchet the door to "twist" it until it fits the quarter opening evenly.



# 1955-57 CHEVY BODIES 1955-57 CHEVY 2-DOOR HARDTOP, SEDAN & CONVERTIBLE BODIES



Assembled in the USA with Real Steel!



Bodies ship truck freight via body shipping table, or can be picked up in Sanford, FL with no freight charges.

The car that started it all for Real Deal Steel. Since 2011 we have built & shipped over 1,000 of these classic bodies. We have continually improved our fixtures, parts & assembly processes to offer you the best Tri-5 body available anywhere. We take special care to eliminate the famous "quarter panel bubble" & we make certain the doors & deck lid fit properly so you'll have fantastic gaps once mounted on your chassis! We also test fit a windshield & back glass in every body to ease the job of installing glass – which is never easy in a Tri-5. Available with our stock, "Smoothie" or 4" recessed firewall & larger trans tunnel – we also install our wider wheel tubs in any body style to allow you to create that Pro-Touring look with up to 335mm rear tires.

- Tri-Five Chassis, Grille & Splash Pans ..... 9
- Tri-Five Bumpers..... 10-11
- Tri-Five Core Supports & Battery Tray ..... 11
- Tri-Five Cowl, Firewall & Wipers..... 12
- Tri-Five Fenders & Inner Fenders..... 13
- Tri-Five Roof & A-Pillar ..... 14
- Tri-Five Convertible & Door Jamb..... 15
- Tri-Five Hood & Glove Box ..... 16
- Tri-Five Door, Door Handles & Mirrors ..... 17
- Tri-Five Rocker Panels & Floor Pans ..... 18
- Tri-Five Floor Pans & Trans Tunnel ..... 19
- Tri-Five Package Tray, Wheelhouse..... 20
- Tri-Five Quarter Panels..... 21
- Tri-Five Trunk & Cargo Area ..... 22
- Tri-Five Tailgate/Liftgate & Fin ..... 23
- Tri-Five Exterior Molding ..... 24
- Tri-Five Exterior Molding & Back Glass ..... 25
- Tri-Five Windshield & Window Felts ..... 26
- Tri-Five Vent Window & Side Glass..... 27
- Tri-Five Side Window & Lighting ..... 28
- Tri-Five Quarter Window & License Plate ... 29
- Tri-Five Engine, Fuel & Steering ..... 30
- Tri-Five Brakes, Suspension & Steering..... 31
- Tri-Five Steering Wheel & Seats ..... 32
- Tri-Five Gauges, Switches & Dash..... 33
- Tri-Five Heater & Interior Molding ..... 34
- Tri-Five Interior Molding & Headliner ..... 35
- Tri-Five Body Shimming Diagram ..... 36



C57CD-13..1957 Convertible Body with Dash, Quarter Panels, Doors & Deck Lid ..... ea .... 21150  
 C57CD-13CTF ..1957 Convertible Body with Dash, Quarter Panels, Doors, Deck Lid & Conv Top Frame ..... ea .... 22849

## TRI-FIVE BODIES

C55CD-12 ... 1955 Convertible Body with Dash & Quarter Panels.....	ea .... 18250
C55CD-13 ... 1955 Convertible Body with Dash, Quarter Panels, Doors & Deck Lid.....	ea .... 21150
C55CD-13CTF ... 1955 Convertible Body with Dash, Quarter Panels, Doors, Deck Lid & Convertible Top Frame.....	ea .... 22849
C55HD-12 ... 1955 2-Door Hardtop Body with Dash & Quarter Panels.....	ea .... 18250
C55HD-13 ... 1955 2-Door Hardtop Body with Dash, Quarter Panels, Doors & Deck Lid.....	ea .... 21150
C55SD-12 ... 1955 2-Door Sedan Body with Dash & Quarter Panels.....	ea .... 18250
C55SD-13 ... 1955 2-Door Sedan Body with Dash, Quarter Panels, Doors & Deck Lid.....	ea .... 21150
C56CD-12 ... 1956 Convertible Body with Dash & Quarter Panels.....	ea .... 19150
C56CD-13 ... 1956 Convertible Body with Dash, Quarter Panels, Doors & Deck Lid.....	ea .... 22050
C56CD-13CTF ... 1956 Convertible Body with Dash, Quarter Panels, Doors, Deck Lid & Convertible Top Frame.....	ea .... 23749
C57CD-12 ... 1957 Convertible Body with Dash & Quarter Panels.....	ea .... 18250

C57C-R..... 1955 OR 1957 2-Door Hardtop or Sedan Race Body with Quarter Panels, Top Skin, Drip Rails, Rear Deck Filler & Rear Tailpan.....	ea ..... 9500
C57HD-12 ... 1957 2-Door Hardtop Body with Dash & Quarter Panels.....	ea .... 18250
C57HD-13 ... 1957 2-Door Hardtop Body with Dash, Quarter Panels, Doors & Deck Lid.....	ea .... 21150
C57SD-12 ... 1957 2-Door Sedan Body with Dash & Quarter Panels.....	ea .... 18250
C57SD-13 ... 1957 2-Door Sedan Body with Dash, Quarter Panels, Doors & Deck Lid.....	ea .... 21150

## TRI-FIVE BODY OPTIONS

6LT-567-Upgrade ... 1955-57 Enlarged Transmission Tunnel Body Upgrade.....	ea ..... 699
WWT-Conversion ... 1955-57 Body Mini-Tub Option.....	pr ..... 1250
RFW-56-Upgrade... 1955-56 4" Recessed Smoothie Steel Firewall Upgrade.....	ea ..... 1199
C56-SFW..... 1955-56 Smoothie Firewall Upgrade.....	ea ..... 200
RFW-57-Upgrade... 1957 4" Recessed Smoothie Steel Firewall Upgrade.....	ea ..... 1199
C57-SFW..... 1957 Smoothie Firewall Option.....	ea ..... 200





PHRC-567

## TRI-FIVE CHASSIS

PGSC-567 ..... 1955-57 PRECISION "Gasser" Chassis\* ..... ea ..... 11249.99  
 PHRC-567 ..... 1955-57 PRECISION "Hot Rod" Chassis\* ..... ea ..... 14949.99  
 \*Additional shipping charges may apply.



## TRI-FIVE FRAME

HAV2P-567.. 1955-57 Gasser Bare Steel Front Spreader Bar..... ea ... 279.99  
 HAV1S-567 . 1955-57 Gasser Stainless Steel Front Spreader Bar ea ... 349.99

## TRI-FIVE FRAME UPGRADES



TFKS-567

TFK-567..... 1955-57 Custom Tubular Frame Upgrade..... kit..... 314.99  
 TFKS-567..... 1955-57 Custom Super-Series Tubular Frame Upgrade..... kit..... 734.99

## TRI-FIVE BODY MOUNTS



BMSS-567



BMKH-567

20-189 ..... 1955-57 Sedan/Wagon/Nomad Body Bolts..... kit.... 20.99  
 20-190 ..... 1955-57 2-Door Hardtop Body Bolts ..... kit.... 20.99  
 20-191 ..... 1955-57 Convertible Body Bolts ..... kit.... 20.99  
 BMKS-567 ... 1955-57 Sedan & Wagon Body Mounts..... set... 94.99  
 BMKH-567 .. 1955-57 2-Door Hardtop Body Mounts..... set... 94.99  
 BMKC-567... 1955-57 Convertible Body Mounts ..... set... 59.99  
 BMK1-567 ... 1955-57 Single Body Mount..... ea ... 14.99  
 BMSS-567 ... 1955-57 Body Mount Shims Set Of 10 ..... set..... 9.99

## 1955-57 CHEVY SMALL FRAME BRACKET

A Real Deal Steel exclusive, made right here in Sanford, FL USA. This bracket is required when converting a sedan or wagon frame to hardtop or convertible. Also to be used to repair rusty or damaged original brackets.

This bracket provides the body-to-frame mount under the quarter window area on all 2-door hardtops and convertibles. Can also be used as the upper inner trunk mount on convertibles. The bracket is sized for hardtop body mount use but comes with a weld-in reducer washer for use on convertible.

SFB-567 ..... 1955-57 2-Dr Hardtop/Conv Small Frame Bracket ea ..... 59.99



## 1955 & 1957 CHEVY 4-DOOR TO 2-DOOR CONVERSION KITS

So you really want a '55 or '57 2-door sedan but you can only find a nice 4-door?

Since the basic body structure (top skin, windshield and back glass, rear deck, back seat structure, trunk floor and trunk lid) is exactly the same, conversion is a breeze! Our kits include all of the major parts you need: outer quarter panels, inner quarter panels (available stock or mini-tubbed), doors, outer rocker panels, inner lock pillars and upper B-pillars. Requires extensive cutting, welding, fabrication and measuring.



4D2DKT-55

4D2DK-55 ..... 1955 4-Dr Sedan to 2-Dr Sheetmetal Conv.\* ..kit....5999.99  
 4D2DK-57 ..... 1957 4-Dr Sedan to 2-Dr Sheetmetal Conv\* ..kit....5999.99  
 4D2DKT-55 ..... 1955 4-Door Sedan to 2-Door Sedan Tubbed Sheetmetal Conversion\* .....kit....5999.99  
 4D2DKT-57 ..... 1957 4-Door Sedan to 2-Door Sedan Tubbed Sheetmetal Conversion\* .....kit....5999.99

CPG-55



GCS-57

GSS-57



GMD-55

GTB-55



GTB-55

## TRI-FIVE GRILLE



TP1401

CPG-55.....1955 Chrome Grille .....ea .. 394.99  
 GMD-55.....1955 4-Piece Chrome Grille Surround Moldings .....set .. 369.99  
 GTB-55 .....1955 Upper Grille Fender Tie Bar .....ea .... 59.99  
 GTBC-55....1955 Chrome Upper Grille Fender Tie Bar .....ea .... 79.99  
 SSG-55.....1955 Stainless Steel Grille .....ea ..... 499.99  
 CPG-56.....1956 Chrome Grille .....ea .. 379.99  
 GAB-56 .....1956 Grille to Fender Angle Brackets .....pr ..... 24.99  
 GABS-56 ...1956 Grille to Fender Stainless Steel Angle Brackets ..pr ..... 29.99  
 GTB-56 .....1956 Upper Grille Fender Tie Bar .....ea .... 56.99  
 GTBC-56...1956 Chrome Upper Grille Fender Tie Bar .....ea .... 89.99  
 LGM-56.....1956 Chrome Lower Grille Molding .....ea .. 249.99  
 GG-57 .....1957 Gold Grille .....ea .. 139.99  
 GBB-57 .....1957 Grillebar End Brackets .....pr ..... 49.99  
 GCS-57 .....1957 Grille Complete Installation Hardware.....kit..... 26.99  
 GTB-57 .....1957 Upper Grille Fender Tie Bar .....ea .. 119.99  
 SG-57 .....1957 Silver Grille.....ea .. 139.99  
 TP1402.....1957 Grillebar Emblem Installation.....kit..... 19.99  
 TP1400.....1957 Grillebar Emblem .....ea .... 49.99  
 TP1401.....1957 Chrome Grillebar Assembly.....ea .. 399.99  
 TP1401A....1957 Grillebar Parking Light Housings .....pr ..... 28.99  
 GSS-57.....1957 Grille Tie Bar To Front Fender Shims.....set..... 7.99

FSP-57



FSP-55



## TRI-FIVE FRONT SPLASH PANS



FSP-56

FSP-55 ..... 1955 Splash Pan 3-Piece .....set ... 199.99  
 FSP-56 ..... 1956 Splash Pan .....ea..... 199.99  
 FSP-57 ..... 1957 Splash Pan .....ea..... 199.99



**CHEVY  
"SMOOTHIE"  
1-PIECE  
FRONT &  
REAR  
BUMPERS**



*Nothing cleans up the look of a nice '55-57 like a set of our "Smoothie" bumpers. Manufactured*



*in one piece – just like the original GM "California" one-piece chrome bumpers except ours have all of the ugly bumper bolt and guard holes eliminated. They are perfectly smooth! The center brackets are welded to the bumper before final finish and copper/nickel/chrome plating to ensure a wave-free surface. In addition, bolt pockets are installed at each bumper brace location so that your stock bumper braces can be used – without showing those ugly bolts!*

**TRI-FIVE BUMPERS**

- SBGF-55..... 1955 Chrome Standard Front Bumper Guards.....pr ... 179.99
- SBGR-55..... 1955 Chrome Standard Rear Bumper Guards.....pr ... 179.99
- 20-305..... 1955 Rear Bumper Mounting Bolts .....kit ..... 21.99
- 20-601..... 1955 Rear Bumper Stainless Steel Mounting Bolts .....kit ..... 41.99
- CRBC-55..... 1955 Chrome "California" 1-Pc Rear Bumper .....ea... 399.99
- FBC-55..... 1955 Front Bumper Center Show Quality USA Chrome ea... 149.99
- FBS-55..... 1955 Chrome Front Bumper 3-Pc with Brackets.....set .. 474.99
- FBSWG-55.. 1955 Chrome Front Bumper with Guards 5-Pc.....set .. 399.99
- LRBE-55..... 1955 Left Rear Bumper End  
Show Quality USA Chrome .....ea... 154.99
- RBC-55..... 1955 Rear Bumper Center - Non Wagon  
Show Quality USA Chrome .....ea... 134.99
- RRBE-55 ..... 1955 Right Rear Bumper End  
Show Quality USA Chrome .....ea... 154.99
- RBCW-55..... 1955 Station Wagon & Nomad Rear  
Bumper Center Show Quality USA Chrome .....ea... 154.99
- RBS-55..... 1955 Chrome Rear Bumper 3-Pc Non-Wagon .....ea... 474.99
- RBSW-55 ..... 1955 Chrome Rear Bumper 3-Pc Wagon/Nomad....set .. 489.99
- RBSWG-55.. 1955 Chrome Non-Wagon Rear Bumper  
with Guards 5-Pc.....set .. 499.99
- SS-1070 ..... 1955 Rear Body to Bumper Rubber Seal .....ea..... 15.99
- WRBG-55.... 1955 Wagon/Nomad Chrome Rear Bumper Guards...pr ... 199.99
- 20-304..... 1955-56 Front Bumper Mounting Bolts.....kit ..... 20.99
- 20-600..... 1955-56 Front Bumper Stainless Steel Mounting Bolts..kit ..... 37.99
- LFBE-56..... 1955-56 Left Front Bumper End  
Show Quality USA Chrome .....ea... 159.99
- FBSWG-56.. 1956 Chrome Front Bumper with Guards 5-Pc.....set .. 589.99
- FBC-56..... 1956 Front Bumper Center Show Quality USA Chrome ea... 149.99
- RFBE-56..... 1955-56 Right Front Bumper End  
Show Quality USA Chrome .....ea... 159.99
- 20-306..... 1956 Rear Bumper Mounting Bolts .....kit ..... 21.99
- 20-602..... 1956 Rear Bumper Stainless Steel Mounting Bolts .....kit ..... 41.99
- FBS-56..... 1956 Chrome Front Bumper 3-Piece.....set .. 499.99
- RBC-56..... 1956 Rear Bumper Center - Non Wagon  
Show Quality USA Chrome .....ea... 154.99
- RBSWG-56.... 1956 Chrome Non-Wagon Rear Bumper w/Guards 5-Pc.....set ..... 489.99
- RBCAWG-56 ... 1956 One-Piece Chrome Non-Wagon "California"  
Rear Bumper with Guards 3-Pc .....set .. 499.99
- RBCO-56 .... 1956 One-Piece Chrome "California" Rear Bumper.ea... 549.99
- RBCW-56..... 1956 Station Wagon & Nomad Chrome  
Rear Bumper Center.....ea... 289.99
- RBEL-56..... 1956 Chrome Left Rear Bumper End  
Show Quality USA Chrome .....ea... 154.99

- CFBS-55..... 1955 California "Smoothie" Style Chrome Front Bumper....419.99
- CRBS-55 ..... 1955 California "Smoothie" Style Chrome Rear Bumper.....419.99
- USCFBS-55.. 1955 California Smoothie Style Painted Front Bumper .....299.99
- USCRBS-55.. 1955 California Smoothie Style Painted Rear Bumper .....299.99
- CFBS-56..... 1956 California "Smoothie" Style Chrome Front Bumper....499.99
- CRBS-56 ..... 1956 California "Smoothie" Style Chrome Rear Bumper.....499.99
- 0903-012 .... 1957 California "Smoothie" Style Chrome Front Bumper...599.99
- RBEB-56..... 1956 Chrome Right Rear Bumper End  
Show Quality USA Chrome .....ea... 154.99
- RBG-56 ..... 1956 Chrome Standard Rear Bumper Guards.....pr ... 179.99
- RBK-56 ..... 1956 Chrome Rear Bumper 3-Piece.....set .. 469.99
- SBGF-56..... 1956 Chrome Standard Front Bumper Guards.....pr ... 179.99
- RBGW-56 .... 1956 Nomad & Station Wagon Chrome  
Rear Bumper Guards.....pr ... 269.99
- RBGWC-56 . 1956 Nomad & Station Wagon Chrome  
Rear Bumper Guards with License Lights.....set .. 319.99
- SS-1090 ..... 1956 Rear Body to Bumper Seal.....ea..... 17.99
- 20-364A..... 1957 Front Bumper Mounting Bolts .....kit ..... 25.99
- 20-365A..... 1957 Rear Bumper Mounting Bolts .....kit ..... 23.99
- 20-603..... 1957 Front Bumper Stainless Steel Mounting Bolts .....kit ..... 44.99
- 20-604..... 1957 Rear Bumper Stainless Steel Mounting Bolts .....kit ..... 46.99
- FBAG-57 ..... 1957 Chrome Front Bumper Accessory Guards.....pr ... 294.99
- FBI-57 ..... 1957 Front Bumper Stainless Steel Bullet Inserts .....pr ..... 44.99
- FBC-57..... 1957 Front Bumper Center Show Quality USA Chrome ea... 199.99
- FBS-57 ..... 1957 5-Piece Chrome Front Bumper .....set .. 649.99
- LFBE-57 ..... 1957 Left Front Bumper End  
Show Quality USA Chrome .....ea... 199.99
- RFBE-57..... 1957 Right Front Bumper End  
Show Quality USA Chrome .....ea... 199.99
- LFBG-57 ..... 1957 Left Front Bumper Guard Bullet  
Show Quality USA Chrome .....ea..... 89.99
- RFBG-57 .... 1957 Right Front Bumper Guard Bullet  
Show Quality USA Chrome .....ea..... 89.99
- FBOP-57 ..... 1957 "California" Chrome 1-Pc Front Bumper .....ea... 799.99
- RBB-57 ..... 1957 Rubber Bumper Bullets .....pr ..... 44.99
- RBS-57..... 1957 Chrome Non-Wagon Rear Bumper w/Ends 3-Pc.....set ..... 569.99
- RBCWD-57.. 1957 Station Wagon/Nomad/Sedan Delivery Chrome Rear  
Bumper Center without Bumper Guard Holes .....ea... 329.99
- RBC-57..... 1957 Rear Chrome Bumper Center Except  
Nomad & Wagon.....ea... 299.99
- RBCU-57 .... 1957 Non-Wagon Rear Bumper Center  
Show Quality USA Chrome .....ea... 299.99
- RBCW-57..... 1957 Station Wagon/Nomad/Sedan Delivery  
Chrome Rear Bumper Center .....ea... 399.99
- RBEU-57 ..... 1957 Rear Bumper Ends Show Quality USA Chrome..pr ... 389.99
- SS-1100 ..... 1957 Rear Body to Bumper Seal.....ea..... 17.99



**TRI-FIVE BUMPER BRACKETS**

BES-55	.....	1955 Rear Bumper End Spacers.....pr	.....	19.99
LBEB-55	.....	1955 Left Front Bumper Diagonal End Bracket.....ea	.....	29.99
LFRRB-55	.....	1955 Left Front/Right Rear Center Bumper Bracket..ea	.....	27.99
LRBEB-55	.....	1955 Left Rear Bumper Diagonal End Bracket.....ea	.....	24.99
RFBEB-55	.....	1955 Right Front Bumper Diagonal End Bracket.....ea	.....	29.99
RFLRB-55	.....	1955 Right Front/Left Rear Center Bumper Bracket..ea	.....	27.99
RRBEB-55	.....	1955 Right Rear Bumper Diagonal End Bracket.....ea	.....	24.99
BBL-55	.....	1955 Left Front Fender to Bumper Outer Bracket.....ea	.....	44.99
BBR-55	.....	1955 Right Fender to Bumper Outer Bracket.....ea	.....	44.99
FBBS-55	.....	1955 Front Bumper Bracket Set 4-Pieces.....set	..	114.99
RBBS-55	.....	1955 Rear Bumper Bracket Set 4-Pieces.....set	..	104.99
11-256	.....	1956 Left Front Bumper End Bracket.....ea	.....	39.99
11-257	.....	1956 Right Front Bumper End to Fender Bracket.....ea	.....	39.99
11-271	.....	1956 Left Front Bumper Bracket.....ea	.....	24.99
11-272	.....	1956 Right Front Bumper Bracket.....ea	.....	24.99
LFBD-56	.....	1956 Left Front Frame to Bumper End Bracket.....ea	.....	59.99
RFBD-56	.....	1956 Right Front Frame to Bumper End Bracket.....ea	.....	59.99
11-273	.....	1956 Left Rear Bumper Bracket.....ea	.....	59.99
11-274	.....	1956 Right Rear Bumper Bracket.....ea	.....	59.99
LRBEB-56	.....	1956 Left Rear Bumper Diagonal End Bracket.....ea	.....	59.99
RRBEB-56	.....	1956 Right Rear Bumper Diagonal End Bracket.....ea	.....	59.99
QPB-56	.....	1956 Rear Bumper Bracket to Quarter Panel Braces...pr	.....	39.99
RBEBK-57	.....	1957 Rear Bumper End Inner Brackets.....pr	.....	99.99
RBBC-57	.....	1957 Rear Bumper Center Brackets.....pr	.....	79.99
RBBE-57	.....	1957 Rear Bumper End Diagonal Braces.....pr	.....	99.99
RBBS-57	.....	1957 Rear Bumper Brackets 6-Piece.....set	..	239.99
FBBS-57	.....	1957 Front Bumper Brackets 10-Piece.....set	..	299.99
LFBD-57	.....	1957 Left Front Frame to Bumper End Bracket.....ea	.....	29.99
FFFB-57	.....	1957 Left Front Bumper to Fender Bracket.....ea	.....	29.99
FLDB-57	.....	1957 Left Front Bumper Large Diagonal Bracket.....ea	.....	29.99
LFMBB-57	.....	1957 Left Front Main Center Bumper Bracket.....ea	.....	29.99
RFBD-57	.....	1957 Right Front Frame to Bumper End Bracket.....ea	.....	29.99
FFFB-57	.....	1957 Right Front Bumper to Fender Bracket.....ea	.....	27.99
RFLDB-57	.....	1957 Right Front Bumper Large Diagonal Bracket...ea	.....	29.99
RFMBB-57	.....	1957 Right Front Main Center Bumper Bracket.....ea	.....	29.99



**TRI-FIVE CORE SUPPORTS**

CCSK6-55	...	1955 6-Cyl Chrome Radiator Core Support.....kit	.....	499.99
CCSTB-55	...	1955 Chrome Radiator Core Support Top Bar.....ea	.....	199.99
CRB-55	.....	1955 Chrome Radiator Support Baffles.....pr	.....	199.99
CS6-55	.....	1955 6-Cylinder Core Support.....ea	.....	294.99
CS8-55	.....	1955 V8 Core Support.....ea	.....	299.99
CSTB-55	.....	1955 Radiator Core Support Top Bar.....ea	.....	129.99
RFPL-55	.....	1955 Left Radiator Core Support Filler Panel.....ea	.....	41.99
RFPR-55	.....	1955 Right Radiator Core Support Filler Panel.....ea	.....	41.99
RFPP-55	.....	1955 Radiator Core Support Filler Panels.....pr	.....	79.99
PTK-5572	...	1955-72 Radiator Petcock & Drain Hose kit 1/4" NPT..ea	.....	19.99
RRK-567	.....	1955-57 Radiator Relocation (V8 to 6 Cyl).....kit	.....	39.99
TTBT-567	.....	1955-57 Radiator Insect "Bug" Screen.....ea	.....	39.99
CCSK6-56	...	1956 6-Cyl Chrome Radiator Core Support.....kit	.....	524.99
CCSTB-56	...	1956 Chrome Radiator Core Support Top Bar.....ea	.....	199.99
CRB-56	.....	1956 Chrome Radiator Support Baffles.....pr	.....	199.99
CS6-56	.....	1956 6-Cylinder Core Support.....ea	.....	294.99
CS8-56	.....	1956 V8 Core Support.....ea	.....	299.99
CSTB-56	.....	1956 Radiator Core Support Top Bar.....ea	.....	129.99
RFPL-56	.....	1956 Left Radiator Core Support Filler Panel.....ea	.....	41.99
RFPR-56	.....	1956 Right Radiator Core Support Filler Panel.....ea	.....	41.99
RFPP-56	.....	1956 Radiator Core Support Filler Panels.....pr	.....	79.99
RDSPL-67	.....	56-57 Left Lower Rad Support to Frame Filler Panel..ea	.....	104.99
RDSPR-67	.....	56-57 Right Lower Rad Support to Frame Filler Panel..ea	.....	104.99
CCSK6-57	...	1957 6-Cyl Chrome Radiator Core Support.....kit	.....	499.99
CCSTB-57	...	1957 Chrome Radiator Core Support Top Bar.....ea	.....	239.99
CRB-57	.....	1957 Chrome Radiator Support Baffles.....pr	.....	199.99
CS6-57	.....	1957 6-Cylinder Core Support.....ea	.....	299.99
CS8-57	.....	1957 V8 Core Support.....ea	.....	299.99
CSTB-57	.....	1957 Radiator Core Support Top Bar.....ea	.....	129.99
RFPL-57	.....	1957 Left Radiator Core Support Filler Panel.....ea	.....	41.99
RFPR-57	.....	1957 Right Radiator Core Support Filler Panel.....ea	.....	41.99
RFPP-57	.....	1957 Radiator Core Support Filler Panels.....pr	.....	79.99
CSRBV8-567	..	1955-57 V8 Rad Support Lower Air Baffle.....ea	.....	39.99
RSMK-567	....	1955-57 Radiator Support Mount & Shim Kit Complete.....kit	.....	19.99
FFS-567	.....	1955-57 Radiator Core Support to Front Fenders Shim.....set	.....	7.99

**TRI-FIVE FRONT END FASTENER KITS**

20-152



20-150	.....	1955 Front End Sheetmetal Fasteners .kit	.....	89.99
20-150SS	.....	1955 Stainless Steel Button Head Front End Sheetmetal Fasteners.....kit	.....	84.99
20-151	.....	1956 Front End Sheetmetal Fasteners.....kit	.....	94.99
20-151SS	.....	1956 Stainless Steel Button Head Front End Sheetmetal Fasteners.....kit	.....	84.99
20-152	.....	1957 Front End Sheetmetal Fasteners.....kit	.....	94.99
20-152SS	.....	1957 Stainless Steel Button Head Front End Sheetmetal Fasteners.....kit	.....	89.99

**TRI-FIVE BATTERY**



BAT-56	.....	1955-56 Battery Hold Down.....kit	.....	24.99
BAT-57	.....	1957 Battery Hold Down.....kit	.....	19.99
BT-56	.....	1955-56 Battery Tray.....ea	.....	51.99
BT-57	.....	1957 Battery Tray.....ea	.....	51.99



**TRI-FIVE COWL**

CBL-567	..... 1955 All & 1956-57 Convertible Left Inner Cowl to Floor Brace.....ea...	109.99
CBR-567	..... 1955 All & 1956-57 Convertible Right Inner Cowl to Floor Brace.....ea...	109.99
CSPL-56	..... 1955-56 Left Cowl Side Panel.....ea.....	94.99
CSPR-56	..... 1955-56 Right Cowl Side Panel.....ea.....	94.99
CVPU-56	..... 1955-56 Used Top Cowl Vent Grille Panel.....ea.....	99.99
DO13-553PL	..... 1955-56 Hardtop/Nomad Left Cowl Side Panel A-Pillar Assembly.....ea...	599.99
DO13-553PR	..... 1955-56 Hardtop/Nomad Right Cowl Side Panel A-Pillar Assembly.....ea...	599.99
DO13-554PL	..... 1955-56 Convertible Left Cowl Side Panel A-Pillar Assembly.....ea...	599.99
DO13-554PR	..... 1955-56 Convertible Right Cowl Side Panel A-Pillar Assembly.....ea...	599.99
DO13-555PL	..... 1955-56 Sedan & Station Wagon Left Cowl Side Panel A-Pillar Assembly.....ea...	599.99
DO13-555PR	..... 1955-56 Sedan & Station Wagon Right Cowl Side Panel A-Pillar Assembly.....ea...	599.99
LCP-56	..... 1955-56 Lower Inner Cowl Panel/Plenum.....ea...	429.99
TCP-55C	..... 1955-56 Top Cowl Panel with Windshield Pinch Weld Flange.....ea...	599.99
CSPL-57	..... 1957 Left Outer Cowl Side Panel with Hinge Plate Pockets.....ea.....	94.99
CSPR-57	..... 1957 Right Outer Cowl Side Panel with Hinge Plate Pockets.....ea.....	94.99
DO13-552PL	..... 1957 Sedan and Station Wagon Left Cowl Side Panel A-Pillar Assembly.....ea...	599.99
DO13-552PR	..... 1957 Sedan & Station Wagon Right Cowl Side Panel A-Pillar Assembly.....ea...	599.99
DO13-55PL	..... 1957 Hardtop/Nomad Left Cowl Side Panel A-Pillar Assembly.....ea...	599.99
DO13-55PR	..... 1957 Hardtop/Nomad Right Cowl Side Panel A-Pillar Assembly.....ea...	599.99
DO13-551PL	..... 1957 Conv Left Cowl Side Panel A-Pillar Assy.....ea...	599.99
DO13-551PR	..... 1957 Conv Right Cowl Side Panel A-Pillar Assy.....ea...	599.99
TCP-57C	..... 1957 Upper Cowl Panel with Winshield Pinch Weld Flange.....ea...	549.99
FGF-567	..... 1955-57 Front Windshield Lower Gasket Channels (Weld-on).....pr.....	89.99
CDG-567	..... 1955-57 Cowl Side Drain Gutters.....pr.....	39.99

**1955-56 CHEVY "SMOOTHIE" COWL PANEL**

With modern AC systems, use of the factory fresh air vents is often eliminated. The top cowl vent grille remains an "ugly" feature that only invites water and trash into the cowl plenum. Beautify it the easy way with one of our new exact-fit "smoothie" top panels. Simply paint and bolt-on. No cutting or welding required! Allows use of your stock wiper escutcheons.

CVP-56..... 1955-56 Smoothie Top Cowl Vent Grille Panel.....ea... 189.99

**TRI-FIVE FIREWALL**

FGS-55	..... 1955 Firewall Forward Grommets.....set.....	59.99
FWAM-567	.. 1955-57 Used Firewall Accelerator Mechanism.....ea.....	34.99
FW-56	..... 1955-56 Firewall with Braces*.....ea.....	799.99
FWB-56	..... 1955-56 Firewall Braces Only.....pr.....	209.99
SFW-56	..... 1955-56 Smoothie Firewall with Braces.....ea.....	699.99
FGS-56	..... 1956 Firewall Forward Grommets.....set.....	59.99
57FW1	..... 1957 Firewall with Braces*.....ea.....	629.99
FGS-57	..... 1957 Firewall Forward Grommets.....set.....	34.99
FWB-57	..... 1957 Firewall Braces Only.....pr.....	209.99
SFW-57	..... 1957 Smoothie Firewall with Braces.....ea.....	629.99
RDTBSS-57	.. 1957 Stainless Steel RealDuction Tri-Block Firewall Duct Block-Off Panels with Hardware.....set.....	69.99
FWLR-567	..... 55-57 Floor Toe Board Kick Panel Retainer Flange ea.....	28.99
FWPT-67	..... 1956-57 Firewall Pad Fastener Tool.....ea.....	16.99

**1955-57 CHEVY 4" RECESSED "SMOOTHIE" STEEL FIREWALL**

The look and fit of this firewall from Hot Rod Dynamics is hard to beat! Made in the USA with 16-gauge steel and a deep 4" recess to accept any small block, LS or low-profile valve cover big block. The recess opening is 25.5" wide at the face and tapers to 21.5" wide at the back. Allows use of Vintage Air & Raingear aftermarket wiper setups. Requires extensive cutting and welding of the original firewall. Available as an upgrade on any of our 55-57 bodies!

RFW-56 ..... 1955-56 4" Recessed Smoothie Steel Firewall.....ea.... 499.99  
 RFW-57 ..... 1957 4" Recessed Smoothie Steel Firewall.....ea.... 499.99



**TRI-FIVE WIPERS**

EWM-55	..... 1955 Restored Electric Wiper Motor.....ea...	379.99
EWM-56	..... 1956 Restored Electric Wiper Motor.....ea...	379.99
EWM-57	..... 1957 Restored Electric Wiper Motor.....ea...	379.99
SS-1036	..... 1955-57 Wiper Center Drive Seals.....set.....	3.99
WBP-567	..... 1955-57 Polished Stainless Steel Wiper Blades with Rubber Inserts Vacuum or Electric.....pr.....	24.99
WAP-56	..... 1955-56 Polished Stainless Steel Wiper Arms.....pr.....	41.99
WAP-57	..... 1957 Polished Stainless Steel Wiper Arms.....pr.....	41.99
WCD-567	..... 1955-57 Used Windshield Wiper Center Drum.....ea.....	69.99
WCS-56	..... 1955-56 Windshield Wiper Control Switch w/Cable.....ea.....	99.99
WCS-57	..... 1957 Windshield Wiper Control Switch with Cable...ea.....	74.99
WTL-56	..... 1955-56 Left Wiper Transmission with Cables.....ea.....	99.99
WTR-56	..... 1955-56 Right Wiper Transmission with Cables.....ea.....	99.99
WWE-56	..... 1955-56 Chrome Windshield Wiper Escutcheons.....pr.....	54.99
WWE-57	..... 1957 Chrome Windshield Wiper Escutcheons.....pr.....	54.99
WWTS-56	..... 1955-56 Windshield Wiper Transmission Spacers.....pr.....	24.99
WET-567	..... 1955-57 Wiper Escutcheon Nut Tool.....ea.....	16.99
DNT-567	..... 1955-57 Dash Wiper Switch Nut & 1957 Headlight Switch Nut Tool.....ea.....	18.99



**TRI-FIVE FRONT FENDER**

CFBL-55	.....1955 Left Fender Lower Cowl	Mount Bracket at Rocker Panel.....ea.....	39.99	
CFBR-55	.....1955 Right Fender Lower Cowl	Mount Bracket at Rocker Panel.....ea.....	39.99	
55LFF-1	.....1955 Left Front Inner/Outer Fender Assembly*	.....set ...	999.99	
55RFF-1	.....1955 Right Front Inner/Outer Fender Assembly*	.....set ...	999.99	
AGS-55	.....1955 Front Fender Accessory Gravel Shields.....	pr .....	169.99	
IFBL-55	.....1955 Left Front Fender Lower Inner Brace.....	ea.....	69.99	
IFBR-55	.....1955 Right Front Fender Lower Inner Brace .....	ea.....	69.99	
FFL-55	.....1955 Left Front Fender* .....	ea.....	999.99	
FFR-55	.....1955 Right Front Fender* .....	ea.....	999.99	
FFP-55	.....1955 Left & Right Front Fenders Pair*.....	pr .....	1799.99	
FFPL-55	.....1955 Left Front Fender Lower Repair Panel .....	ea.....	119.99	
FFPR-55	.....1955 Right Front Fender Lower Repair Panel.....	ea.....	119.99	
HLCL-55	.....1955 Left Headlight Cap Repair Panel.....	ea.....	114.99	
HLCR-55	.....1955 Right Headlight Cap Repair Panel.....	ea.....	114.99	
TCB-55	.....1955 Fender to Top Cowl Brackets .....	pr .....	69.99	
FASG-55	.....1955 Front Fender Anti-Squeak Gaskets.....	set .....	17.99	
FASG-56	.....1956 Front Fender Anti-Squeak Gaskets.....	set .....	22.99	
FFIHL-55	.....1955 Left/Right Inner Headlight Cap Repair Panel .....	ea.....	57.99	
AGS-56	.....1956 Front Fender Accessory Gravel Shields.....	pr .....	169.99	
FEX-56	.....1956 Chrome Front Fender Outer Ribbed	Extensions with Backing Plates .....	pr .....	159.99
FFL-56	.....1956 Left Front Fender* .....	ea.....	1199.99	



FFR-56	.....1956 Right Front Fender* .....	ea.....	1199.99
FFP-56	.....1956 Left & Right Front Fenders Pair*.....	pr .....	2199.99
FFPL-56	.....1956 Left Front Fender Lower Repair Panel .....	ea.....	99.99
FFPR-56	.....1956 Right Front Fender Lower Repair Panel.....	ea.....	99.99
FRPL-56	.....1956 Left Front Fender Headlight Area Repair Panel .....	ea.....	279.99
FRPR-56	.....1956 Right Front Fender Headlight Area Repair Panel .....	ea.....	279.99
HLCL-56	.....1956 Left Headlight Cap Repair Panel.....	ea.....	94.99
HLCR-56	.....1956 Right Headlight Cap Repair Panel.....	ea.....	94.99
TCB-57	.....1957 Upper Fender to Cowl Brackets.....	pr .....	79.99
IFLB-57	.....1957 Left Front Fender Rear Inner Brace.....	ea.....	104.99
IFRB-57	.....1957 Right Front Fender Rear Inner Brace .....	ea.....	104.99
FFPL-57	.....1957 Left Front Fender Lower Repair Panel .....	ea.....	73.99
FFPR-57	.....1957 Right Front Fender Lower Repair Panel.....	ea.....	73.99
GLV-57	.....1957 Gold Fender Louvers.....	set .....	49.99
SLV-57	.....1957 Silver Fender Louvers .....	set .....	54.99
CLV-57	.....1957 Chrome Fender Louvers.....	set .....	74.99
LFF-57	.....1957 Left Front Fender with Trim Holes*+ .....	ea.....	539.99
RFF-57	.....1957 Right Front Fender with Trim Holes*+ .....	ea.....	539.99
FFP-57	.....1957 Left & Right Front Fenders with Trim Holes Pair* .....	pr .....	979.99
LFF150-57	.....1957 Left Front Fender without Trim Holes*+ .....	ea.....	539.99
RFF150-57	.....1957 Right Front Fender without Trim Holes*+ .....	ea.....	539.99
FFP150-57	.....1957 Left & Right Front Fenders w/o Trim Holes Pair* .....	pr.....	979.99
FASG-57	.....1957 Front Fender Anti-Squeak Gaskets.....	set .....	18.99



**TRI-FIVE FRONT INNER FENDERS**

IFFL-55	.....1955 Left Front Inner Fender Lower Extension .....	ea .....	89.99
IFRF-55	.....1955 Right Inner Fender Lower Extension .....	ea .....	89.99
IFOL-55	.....1955 Left Front Fender to Inner Fender Brace .....	ea .....	62.99
IFOR-55	.....1955 Right Front Fender to Inner Fender Brace.....	ea .....	62.99
LIF-55	.....1955 Left Inner Fender* .....	ea .....	139.99
RIF-55	.....1955 Right Inner Fender* .....	ea .....	139.99
LIFC-55	.....1955 Left Inner Fender Custom with No Holes* .....	ea .....	179.99
RIFC-55	.....1955 Right Inner Fender Custom with No Holes* .....	ea .....	179.99
IFC-56	.....1955-56 Inner Fender to Cowl Brackets .....	pr .....	39.99
FIFS-56	.....55-56 Front Inner Fender Edge to Outer Fender Sealspr .....	pr .....	19.99
IFFL-56	.....1956 Left Front Inner Fender Lower Extension .....	ea .....	79.99
IFRF-56	.....1956 Right Front Inner Fender Lower Extension.....	ea .....	79.99



LIF-56	.....1956 Left Inner Fender* .....	ea .....	259.99
RIF-56	.....1956 Right Inner Fender* .....	ea .....	259.99
RDSPL-67	.....1956-57 Left Lower Rad Support to Frame Filler Panel .....	ea .....	104.99
RDSPL-67	.....1956-57 Right Lower Rad Support to Frame Filler Panel .....	ea .....	104.99
LIF-57	.....1957 Left Inner Fender* .....	ea .....	259.99
RIF-57	.....1957 Right Inner Fender* .....	ea .....	259.99
LIFC-57	.....1957 Left Inner Fender Custom with No Holes* .....	ea .....	299.99
RIFC-57	.....1957 Right Inner Fender Custom with No Holes* .....	ea .....	299.99
DTSL-57	.....1957 Left Inner Fender Drain Tube Splash Shield .....	ea .....	119.99
DTSR-57	.....1957 Right Inner Fender Drain Tube Splash Shield.....	ea .....	119.99
IFB-57	.....1957 Inner to Outer Fender Brace at Wheelwell .....	ea .....	29.99
IFC-57	.....1957 Inner Fender to Cowl Brackets.....	pr .....	29.99
DSR-57	.....1957 Upper Control Arm Dust Shield Retainers .....	set .....	29.99
IFDT-57	.....1957 Inner Splash Pan Drain Tube .....	ea .....	49.99
FIFS-57	.....57 Front Inner Fender Edge to Outer Fender Seals.....	pr .....	19.99

**1955-57 CHEVY COMPLETE FRONT END SHEET METAL PACKAGES**

Repairing rusty & bent front fenders & hoods can be very time consuming. After hours of straightening and welding, the results can still be disappointing! Cure all of that with one of our complete front sheet metal packages. Available for 1955, 1956 & 1957, kits include outer and inner fenders, hood, radiator core support, core support baffles, inner splash pans and forward main splash pan (with extensions on '55). Available with 6-cylinder or V8 position radiator core support. 1955 & 1956 available with optional "Smoothie" hood. 1957 available for 150 series (no fender trim holes) or 210/Bel Air with trim holes.



- 1955FEP-6..... 1955 Complete Front End Sheetmetal Package with 6-Cylinder Core Support\* ..... kit.... 3299.99
- 1955FEP-6S..... 1955 Complete Front End Sheetmetal Package with 6-Cylinder Core Support & Smoothie Hood\* .. kit.... 3399.99
- 1955FEP-8..... 1955 Complete Front End Sheetmetal Package with V8 Core Support\* ..... kit.... 3299.99
- 1955FEP-8S..... 1955 Complete Front End Sheetmetal Package with V8 Core Support & Smoothie Hood\* ..... kit.... 3399.99
- 1956FEP-6..... 1956 Front End Sheetmetal Package with 6-Cylinder Core Support\* ..... kit.... 4299.99
- 1956FEP-6S..... 1956 Front End Sheetmetal Package with 6-Cylinder Core Support & Smoothie Hood\* .. kit.... 4299.99
- 1956FEP-8..... 1956 Front End Sheetmetal Package with 8-Cylinder Core Support\* ..... kit.... 4299.99
- 1956FEP-8S..... 1956 Front End Sheetmetal Package with V8 Core Support & Smoothie Hood\* ..... kit.... 4299.99
- 1957FEP-6..... 1957 Bel Air & 210 Series Complete Front End Sheetmetal Package w/6-Cylinder Core Support\*+ ..... kit.... 3299.99
- 1957FEP-6-150 .... 1957 150 Series Complete Front End Sheetmetal Package with 6-Cylinder Core Support\*+ ..... kit.... 3299.99
- 1957FEP-8..... 1957 Bel Air & 210 Series Complete Front End Sheetmetal Package with V8 Core Support\*+ .. kit.... 3299.99
- 1957FEP-8-150 .... 1957 150 Series Complete Front End Sheetmetal Package with V8 Core Support\*+ ..... kit.... 3299.99



**TRI-FIVE A-PILLAR**

- AP5H-567 ... 1955-57 Bel Air 2-Door Hardtop & Nomad Restored Upper Windshield Pillar Stainless .....pr ... 179.99
- AP5S-567 .... 1955-57 Bel Air 2 & 4-Door Sedan Restored Upper Windshield Pillar Stainless .....pr ... 179.99
- APBL-567 ... 1955-56 All and 1957 Convertible Left Flat Rocker to A-Pillar Reinforcement Plate .....ea..... 59.99
- APBR-567 .... 1955-56 All and 1957 Convertible Right Flat Rocker to A-Pillar Reinforcement Plate .....ea..... 59.99
- APRCL-56 .... 1955-56 Convertible Left Windshield Pillar/Upper Hinge Area Repair.....kit ... 459.99
- APRCR-56.... 1955-56 Convertible Right Windshield Pillar/Upper Hinge Area Repair.....kit ... 459.99
- APRHL-56 .... 1955-56 2&4-Door Hardtop & Nomad Left Windshield Pillar/Upper Hinge Area Repair.....kit ... 459.99
- APRHR-56.... 1955-56 2&4-Door Hardtop & Nomad Right Windshield Pillar/Upper Hinge Area Repair.....kit ... 459.99
- APRSL-56.... 1955-56 2&4-Door Sedan & Station Wagon Left Windshield Pillar/Upper Hinge Area Repairkit ..... 459.99
- APRSR-56 ... 1955-56 2&4-Door Sedan & Station Wagon Right Windshield Pillar/Upper Hinge Area Repair .....kit ... 459.99
- LLHP-56..... 1955-56 Left Lower A-Pillar Hinge Repair Panel .....ea... 139.99
- RLHP-56 ..... 1955-56 Right Lower A-Pillar Hinge Repair Panel.....ea... 139.99
- APSH4-67 ... 1956-57 Bel Air 4-Door Hardtop Restored Upper Windshield Pillar Stainless .....pr ... 179.99
- APBL-57 ..... 1957 2&4-Door Hardtop 2&4-Door Sedan/Wagon/ Nomad/Delivery Left A-Pillar Flat Reinforcement .....ea..... 69.99
- APBR-57 ..... 1957 2&4-Door Hardtop 2&4-Door Sedan/Wagon/ Nomad/Delivery Right A-Pillar Flat Reinforcement .....ea..... 69.99
- APRCL-57 ... 1957 Convertible Left Windshield Pillar/Upper Hinge Area Repair.....kit ... 459.99
- APRCR-57.... 1957 Convertible Right Windshield Pillar/Upper Hinge Area Repair.....kit ... 459.99
- APRHL-57 .... 1957 2&4-Door Hardtop & Nomad Left Windshield Pillar/Upper Hinge Area Repair.....kit ... 459.99
- APRHR-57.... 1957 2&4-Door Hardtop & Nomad Right Windshield Pillar/Upper Hinge Area Repair.....kit ... 459.99
- APRSL-57.... 1957 2&4-Door Sedan & Station Wagon Left Windshield Pillar/Upper Hinge Area Repair.....kit ... 459.99
- APRSR-57 ... 1957 2&4-Door Sedan & Station Wagon Right Windshield Pillar/Upper Hinge Area Repair.....kit ... 459.99
- LLHP-57..... 1957 Left Lower A-Pillar Hinge Repair Panel.....ea... 139.99
- RLHP-57 ..... 1957 Right Lower A-Pillar Hinge Repair Panel .....ea... 139.99



**TRI-FIVE ROOF/TOP**

- HDRL-567.... 1955-57 2-Door Hardtop Left Drip Rail .....ea.... 109.99
- HDRR-567 ... 1955-57 2-Door Hardtop Right Drip Rail .....ea.... 109.99
- HTRF-567 .... 1955-57 2-Dr Hardtop Side Roof/Top Rails .....pr .... 439.99
- HTRS-567 .... 1955-57 2-Door Hardtop Roof Top Structure\* .....ea.... 799.99
- HTS-567..... 1955-57 2-Door Hardtop Roof/Top Panel\*+ .....ea.... 699.99
- RFBHT-567 .. 1955-57 2-Door Hardtop Lateral Top/Roof Brace...kit.... 399.99
- RFBSD-567 .. 1955-57 2&4-Door Sedan Lateral Top/Roof Brace .kit.... 399.99
- SDRL-567 .... 1955-57 2&4-Door Sedan Left Drip Rail .....ea.... 129.99
- SDRR-567 .... 1955-57 2&4-Door Sedan Right Drip Rail .....ea.... 129.99
- SS-1035 ..... 1955-57 Nomad Roofrail Weatherstripping.....pr .... 159.99
- STRS-567.... 1955-57 2-Door Sedan Roof Top Structure+ .....ea.... 799.99
- STS-567..... 1955-57 2&4-Door Sedan Roof Panel\*+ .....ea.... 699.99

**TRI-FIVE BODY GROMMET SETS**

- BGSCV-567 ..... 1955-57 Convertible..... set... 69.99
- BGSHT-567 ..... 1955-57 2-Door Hardtop set... 79.99
- BGSHT4-67 ..... 1956-57 4-Door Hardtop set... 69.99
- BGSNM-567..... 1955-57 Nomad ..... set... 69.99
- BGSSD-567 ..... 1955-57 2-Door Sedan.... set... 79.99
- BGSSD4-567 ... 1955-57 4-Door Sedan.... set... 69.99
- BGSSW2-567 ... 1955-57 2-Door Wagon .. set... 69.99
- BGSSW4-567 ... 1955-57 4-Door Wagon .. set... 69.99
- BGSSD-567 ..... 1955-57 2-Door Sedan.... set... 79.99
- BGSSD4-567 .... 1955-57 4-Door Sedan.... set... 69.99
- BGSSW2-567 ... 1955-57 2-Door Wagon .. set... 69.99
- BGSSW4-567 ... 1955-57 4-Door Wagon .. set... 69.99



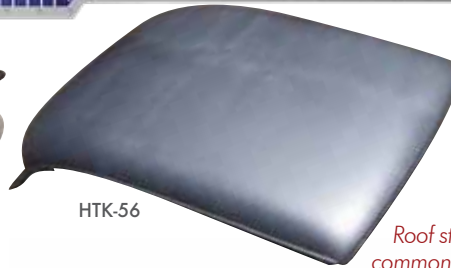

**1955-57 CHEVY  
2-DOOR HARDTOP  
& SEDAN FULLY  
WELDED ROOF/  
TOP ASSEMBLIES**

*Roof structure & top skin rust is increasingly common in the Tri-5's being restored today.*

*Often the top skin has impossible to repair rust near the drip rails and the top structure rots especially in the C-pillar areas. Complete assemblies make top repair much easier – replace the entire top!. It sounds like a big job, but if you measure carefully, test fit your glass, this method is easier and longer lasting than welding a bunch of patches in your original. The 2-door hardtop assemblies are fully fixture welded with drip rails and skin completely attached. The 2-door sedan assemblies have the drip rails and top skin tech-screwed in place because the quarter panels above the quarter window area must be fitted by the end user before final welding. Built on the same fixtures we use to produce our new bodies.*

**TRI-FIVE CONVERTIBLE**

FBW-567	..... 1955-57 Convertible Frame Bracket Washer.....ea.....	9.99
FBWS-567	..... 1955-57 Convertible Frame Bracket Washers .....set ...	119.99
CTL-567	..... 1955-57 Convertible Top Latch Assemblies with Handles.....pr ....	234.99
DPSC-567	..... 1955-57 Convertible Flat Pillar Post Stainless.....pr .....	89.99
CTMB-567	..... 1955-57 Convertible Top Rack Rear Mounting Bracket Assemblies .....pr ....	229.99
20-1132	..... 1955-57 Convertible Top Guide Pin (2 Required) ..ea.....	16.99
20-414	..... 1955-57 Convertible Stainless Steel Boot Snap Trim Clips .....set .....	51.99
20-516	..... 1955-57 Convertible Top Rear Tack Strip Bolts.....set .....	9.99
20-518	..... 1955-57 Convertible Top Rear Top Frame Mount Bracket Bolts .....set .....	14.99
567TC	..... 1955-57 Convertible Top Hydraulic Cylinder (2 Required).....ea.....	129.99
567THC	..... 1955-57 Convertible Top Hydraulic Hoses .....set .....	84.99
567TMP	..... 1955-57 Convertible Top Hydraulic Pump & Motor Assembly.....ea.....	399.99
CBK-5557	..... 1955-57 Convertible Top Hardware.....kit.....	174.99
CRAR-567	..... 1955-57 Convertible Rear Armrest Piston Cover Assemblies .....set ...	369.99
CRTB-567	..... 1955-57 Convertible Top Frame Rear Bow.....ea.....	429.99
CTB-567	..... 1955-57 Convertible Top Header Bow.....ea.....	499.99
CTFCB-567	..... 1955-57 Conv Top Frame Forward Center Bow .....ea.....	129.99
CTRCB-567	..... 1955-57 Conv Top Frame Rear Center Bow ..ea.....	179.99
CTBBL-567	..... 1955-57 Convertible Left Top Mount Box Brace Assembly .....ea.....	314.99
CTBBR-567	..... 1955-57 Convertible Right Top Mount Box Brace Assembly .....ea.....	314.99
CTBP-567	..... 1955-57 Convertible Top Cylinder Floor Brackets..pr ....	149.99
CTF-567	..... 1955-57 New Complete Convertible Top Frame/Bow Assembly*.....ea..	1599.99
CTH-5560	..... 1955-60 Convertible Chrome Top Handles.....pr .....	84.99
CTHS-567	..... 1955-57 Conv Top Handle Chrome Striker Plates .pr .....	67.99
CTS-567	..... 1955-57 Convertible Rear Body Tack Strips.....set ...	389.99
IPMC-567	..... 1955-57 Convertible Inner Vertical Windshield Chrome "A-Pillar" Moldings ..... pr.....	259.99
SS-1030C	..... 1955-57 Convertible Top Roofrail Weatherstripping with Cloth .....set ...	294.99
SS-1030U	..... 1955-57 Convertible Top Replacement Roofrail Weatherstripping .....set ...	239.99
TSC-55	..... 1955-56 Convertible Top Switch Complete with Bracket .....ea.....	239.99
TSC-57	..... 1957 Convertible Top Switch Complete with Bracket.....ea .....	239.99
CDS001	..... 1955-57 Convertible Upper Inner Windshield Stainless Molding Behind Mirror Bracket .....ea .....	32.99
CVWST-567	..... 1955-57 Conv. Upper Inner Windshield Stainless....pr ....	249.99
CVWSU-567	..... 1955-57 Convertible Upper Inner Windshield Stainless Garnish Moldings.....pr ...	159.99
CWSU-567	..... 1955-57 Convertible Upper Outer Center Windshield Stainless Molding .....ea ..	139.99
IBAPC-567	..... 1955-57 Conv Inner Body Access Panel Covers (6).... set.....	94.99

HTK-56	..... 1955-56 2-Door Hardtop Fully Welded Top/Roof Structure and Skin Assembly Complete*.....ea..	2624.99
HTK-57	..... 1957 2-Door Hardtop Fully Welded Top/Roof Structure and Skin Assembly Complete*.....ea..	2624.99
STK2-56	..... 1955-56 2-Door Sedan Top/Roof Structure and Skin Assembly Complete*.....ea..	1889.99
STK2-57	..... 1957 2-Dr Sedan Top/Roof Structure & Skin Assy* .....	1889.99



**TRI-FIVE DOOR JAMB**

BPL-567	..... 1955-57 2-Door Hardtop & Conv. Left Lower Door Jamb Panel.....ea .....	104.99
BPR-567	..... 1955-57 2-Door Hardtop & Conv. Right Lower Door Jamb Panel .....ea .....	104.99
DJBCL-567	..... 1955-57 Conv Left Rear Floor to Door Jamb Brace ea .....	174.99
DJBCL-567	..... 1955-57 Conv Right Rear Floor to Door Jamb Brace ea .....	174.99
DJBHL-567	..... 1955-57 2-Door Hardtop Left Rear Floor to Door Jamb Brace .....ea .....	174.99
DJBHR-567	..... 1955-57 2-Door Hardtop Right Rear Floor to Door Jamb Brace .....ea .....	174.99
DJPL-567	..... 1955-57 HT & Conv. Left Door Jamb Panel .....ea .....	184.99
DJPR-567	..... 1955-57 HT & Conv. Right Door Jamb Panel.....ea .....	184.99
DJSL-567	..... 1955-57 2-Door Sedan, Station Wagon, Sedan Delivery & Nomad Left Door Jamb Panel .....ea .....	109.99
DJSR-567	..... 1955-57 2-Door Sedan, Station Wagon, Sedan Delivery & Nomad Right Door Jamb Panel.....ea .....	109.99
HCDJPL-567	..... 1955-57 Hardtop & Convertible Left Door Jamb Reinforcement Panel .....ea .....	209.99
HCDJPR-567	..... 1955-57 Hardtop & Convertible Right Door Jamb Reinforcement Panel .....ea .....	209.99
DO13-552DL	..... 1955-57 2-Dr Sedan Left Door Jamb Lock Plate .ea .....	179.99
DO13-552DR	..... 1955-57 2-Dr Sedan Right Door Jamb Lock Plate ea .....	179.99
QPJSL-567	..... 1955-57 Left 2-Dr Sedan Quarter Panel Jamb* .ea .....	599.99
QPJSR-567	..... 1955-57 Right 2-Dr Sedan Quarter Panel Jamb* .ea .....	599.99
RDJPP-67	..... 1956-57 4-Door Hardtop Sport Sedan Rear Door Jamb Repair Panels.....pr .....	239.99
DLPP-67	..... 1956-57 4-Door Hardtop Lower Rear Door Jamb Dogleg Repair Panels .....pr .....	169.99
DGL-57	..... 1957 4-Door Sedan & Station Wagon Left Quarter Panel Door Jamb Dogleg Repair Panel ..ea .....	109.99
DGR-57	..... 1957 4-Door Sedan & Station Wagon Right Quarter Panel Door Jamb Dogleg Repair Panel ..ea .....	109.99



**TRI-FIVE HOOD**

HOL-55	..... 1955 Hood Latch.....	ea	..... 99.99
10-162	..... 1955 Hood Spring (2 Required) .....	ea	..... 16.99
11-094	..... 1955 Left Hood Brace Rod.....	ea	..... 25.99
11-095	..... 1955 Right Hood Brace Rod.....	ea	..... 25.99
CHB-55	..... 1955 Chrome Hoodbird.....	ea	..... 109.99
HO-55	..... 1955 Complete Hood* .....	ea	..... 679.99
HOS-55	..... 1955 Steel Custom Smoothie Hood* .....	ea	..... 799.99
HOLS-55	..... 1955 Vertical Hood Latch Support.....	ea	..... 49.99
TP1022	..... 1955 Hood Emblem Assembly.....	ea	..... 79.99
UHB-55	..... 1955 Chrome Hoodbar.....	ea	..... 199.99
HCB-55	..... 1955 Hood Support Cross Brace.....	ea	..... 109.99
HCB-56	..... 1956 Hood Support Cross Brace.....	ea	..... 99.99
HLSP-567	..... 1955-57 Hood Latch Springs.....	set	..... 16.99
20-271	..... 1955-56 Adjustable Hood Stops .....	kit	..... 18.99
20-391D	..... 1955-56 Hood Hinge Bolt .....	kit	..... 18.99
HNG-56	..... 1955-56 Hood Hinges.....	pr	..... 149.99
TCW-56	..... 1955-56 Hood to Cowl Weatherstripping w/Clips..	set	..... 14.99
HASG-56	..... 1955-56 Hood Anti-Squeak Gaskets.....	set	..... 9.99
HOL-56	..... 1956 Hood Latch.....	ea	..... 99.99
CHB-56	..... 1956 Chrome Hoodbird.....	ea	..... 109.99
10-163	..... 1956 Hood Spring (2 Required) .....	ea	..... 16.99
CHV-56	..... 1956 Chrome Hood V.....	ea	..... 54.99
HO-56	..... 1956 Complete Hood* .....	ea	..... 799.99
HOS-56	..... 1956 Steel Custom Smoothie Hood* .....	ea	..... 839.99
HOLS-56	..... 1956 Vertical Hood Latch Support.....	ea	..... 26.99
TP1304	..... 1956 V8 Hood Emblem Assembly.....	ea	..... 59.99
TP1307	..... 1956 Chrome Hoodbar Extensions .....	pr	..... 199.99
TP1308	..... 1956 Chrome Hoodbar.....	ea	..... 239.99
TP1308K	..... 1956 Chrome Hoodbar and Extensions .....	set	..... 399.99
TP1392	..... 1956 6-Cylinder Hood Emblem Assembly.....	ea	..... 129.99
HOL-57	..... 1957 Hood Latch.....	ea	..... 119.99
HOS-57	..... 1957 Vertical Hood Latch Support.....	ea	..... 49.99
10-164	..... 1957 Hood Spring (2 Required) .....	ea	..... 16.99
20-270	..... 1957 Adjustable Hood Stops.....	kit	..... 14.99

20-363A	..... 1957 Hood Hinge to Fender Brackets .....	kit	..... 16.99
20-391A	..... 1957 Hood Hinge Bolts .....	kit	..... 16.99
20-391B	..... 1957 Hood Hardware .....	kit	..... 24.99
HASG-57	..... 1957 Hood Anti-Squeak Gaskets.....	set	..... 11.99
CHV-57	..... 1957 Chrome Hood V.....	ea	..... 119.99
GHV-57	..... 1957 Gold Hood V.....	ea	..... 119.99
HBRU-57	..... 1957 Used Hood Brace Rods.....	pr	..... 44.99
HNG-57	..... 1957 Hood Hinges.....	pr	..... 199.99
HO-57	..... 1957 Complete Hood*+ .....	ea	..... 799.99
HOS-57	..... 1957 Vertical Hood Latch Support.....	ea	..... 49.99
HRB-57	..... 1957 Hood Rocket Mounting Brackets.....	pr	..... 29.99
HRS-57	..... 1957 Chrome Hood Rockets - Best .....	set	..... 249.99
HRSG-57	..... 1957 Chrome Hood Rockets - Good.....	set	..... 189.99
HBE-57	..... 1957 Chrome Hoodbar Extensions - Good .....	pr	..... 104.99
TP1423	..... 1957 Chrome Hoodbar Extensions - Best.....	pr	..... 179.99
TP1425	..... 1957 Chrome Hoodbar.....	ea	..... 239.99
TP1425K	..... 1957 Chrome Hoodbar and Extensions .....	set	..... 399.99
V8G-57	..... 1957 V8 Gold Hood or Trunk Script .....	ea	..... 34.99
V8S-57	..... 1957 V8 Chrome Hood or Trunk Script .....	ea	..... 34.99
TCW-57	..... 1957 Hood to Cowl Rubber Weatherstripping with Clips & Screws .....	set	..... 14.99
2SCOOP-567	..... Steel 2" Cowl Induction Hood Scoop .....	ea	..... 184.99
HLP-567	..... 1955-57 Hood Latch Striker Plate.....	ea	..... 20.99
H LPC-567	..... 1955-57 Chrome Hood Latch Striker Plate .....	ea	..... 44.99

**1957 CHEVY HOOD CROSS BRACE FOR USE WITH CENTER OUTLET RADIATORS**



Made the way GM should have made it. The installation of long water pump small blocks, engines with serpentine belt drives or a big block means you must move the radiator into the 6-cylinder position in front of the core support top bar. To ease radiator hose routing, use of a 1955-56 style center outlet radiator is the way to go. This creates a problem – now the hood won't shut! Our carefully designed cross brace is notched (looks like factory!) in the center to allow use of the center outlet 6-cylinder position radiator. Just paint and install!

HCB-57	..... 1957 Hood Support Cross Brace for Use with Center Outlet Radiators.....	ea	..... 149.99
--------	--	----	--------------

**TRI-FIVE GLOVE BOX**



GBD-56	..... 1955-56 Glove Box Door, Hinge & Arm Assembly .....	ea	..... 169.99
GBD-57	..... 1957 Glove Box Door, Hinge & Arm Assembly .....	ea	..... 169.99
20-153	..... 1955-57 Glove Box Area Screws .....	set	..... 7.99
GB-56	..... 1955-56 Glove Box Liner .....	ea	..... 24.99
GB-57	..... 1957 Glove Box Liner.....	ea	..... 24.99
GBDH-56	..... 1955-56 Glove Box Door Hinge .....	ea	..... 44.99
GBDH-57	..... 1957 Glove Box Door Hinge .....	ea	..... 44.99
GBL-5572	..... 1955-72 Glove Box Light Assembly .....	ea	..... 24.99



**1955 CHEVY LIGHTED LED HOOD EMBLEM**

This custom LED Lighted Emblem & Bezel for your 1955 Chevy (all body styles) includes a LED Emblem Insert, Chrome Bezel, Mounting Studs, 10' of Wiring and Toggle Switch. Installation is simple, requiring NO drilling or other modifications and wires to ignition on 12 volts OR full-time 12 volts!

LEDHE-55	..... 1955 Lighted LED Hood Emblem Assembly.....	ea	..... 139.99
----------	--	----	--------------





**TRI-FIVE DOOR**

- DLL-55 ..... 1955 Left Door Latch.....ea .... 89.99
- DLR-55 ..... 1955 Right Door Latch.....ea .... 89.99
- DSTP-560..... 1955-60 Door Latch Striker Plates.....pr .... 47.99
- DSTPB-560..... 1955-62 Billet Stainless Steel Door Strikers.....pr ... 274.99
- HDOP-57..... 1955 &1957 2-Door Hardtop Left & Right Complete Door Assemblies Pair\* .....pr . 1799.99
- CDOP-57 ..... 1955 & 1957 Convertible Left & Right Complete Door Assemblies Pair\* .....pr . 1799.99
- SDOP-567 ..... 1955-57 2-Door Sedan, Wagon & Sedan Delivery Left & Right Complete Door Assemblies Pair\* .....pr . 1799.99
- HCDP-56 ..... 1956 2-Door Hardtop & Convertible Left & Right Complete Door Assemblies with Bel Air Trim Holes Pair\* .....pr . 1799.99
- 10-286S ..... 1955-57 Door Hinge Repair.....kit..... 6.99
- 11-20571RL ... 1955-57 2-Door Inner Access Cover Small .....ea .... 20.99
- 11-20573RL ... 1955-57 2-Door Inner Access Cover Large.....ea .... 20.99
- 11-223L ..... 1955-57 Door Striker Skid Plates (4) .....set .... 19.99
- 11-223SL..... 1955-57 Left Door Striker Shim .....ea ..... 9.99
- 11-223SR ..... 1955-57 Right Door Striker Shim .....ea ..... 9.99
- 20-202P ..... 1955-57 2-Door Hardtop & Convertible Inner Door Release Rods.....pr..... 29.99
- 20-202SP ..... 1955-57 2-Door Sedan, Station Wagon & Nomad Inner Door Release Rods.....pr ..... 30.99
- DLRH-567 ..... 1955-57 2-Door Hardtop & Conv Door Lock Rods .pr ..... 12.99
- DLRS-567 ..... 1955-57 2&4-Dr Sedan & Nomad Door Lock Rods .pr ..... 13.99
- DLRR-56 ..... 1956 2-Dr Hdtop & Conv Door Lock To Latch Rods..pr ..... 17.99
- 20-284RP ..... 1955-57 Door Hinge to Cowl Bolts (8).....set .... 11.99
- 20-285 ..... 1955-57 Door Hinge to Cowl Screws (8).....set ..... 8.99
- 20-286S ..... 1955-57 Door Hinge to Cowl Bolts (12).....set .... 17.99
- 20-287 ..... 1955-57 Door Latch Screws (10) .....set ..... 7.99
- 20-288 ..... 1955-57 Door Striker Screws (6).....set .... 16.99
- DHL-567 ..... 1955-57 Left Door Hinge .....ea .. 129.99
- DHR-567 ..... 1955-57 Right Door Hinge.....ea .. 129.99
- DHN-567 ..... 1955-57 A-Pillar Door Hinge Caged Nut.....ea .... 14.99
- DRL-567 ..... 1955-57 Left Inner Door Release .....ea .... 39.99
- DRR-567 ..... 1955-57 Right Inner Door Release.....ea .... 39.99
- DSHCL-567 ... 1955-1957 2-Dr Hardtop & Conv Left Door Skin\* .ea .. 299.99
- DSHCR-567 ... 1955-1957 2-Dr Hardtop & Conv Right Door Skin\* ..ea .. 299.99
- DSLL-567..... 1955-57 2-Door Left Door Skin Lower Half.....ea .... 94.99
- DSLRL-567 ..... 1955-57 2-Door Right Door Skin Lower Half .....ea .... 94.99

- DSSL-567 ..... 1955-57 2-Door Sedan & Station Wagon Left Full Door Skin (Also Use for Nomad)\* .....ea .. 389.99
- DSSR-567 ..... 1955-57 2-Door Sedan & Station Wagon Right Full Door Skin (Also Use for Nomad)\* .....ea .. 389.99
- IDBL-567 ..... 1955-57 Left Inner Door Bottom .....ea .. 167.99
- IDBR-567 ..... 1955-57 Right Inner Door Bottom.....ea .. 167.99
- NDOL-567 .... 1955-57 Nomad Left Door\* .....ea .. 999.99
- NDOR-567 ...1955-57 Nomad Right Door\* .....ea .. 999.99
- RDL4-567 .....1955-57 4-Door Sedan & Wagon Rear Door Latches Restored .....pr ..... 89.99
- SDOL-567 ....1955-57 2-Door Sedan & Wagon Left Door\*+ .....ea .. 999.99
- SDOR-567 ....1955-57 2-Door Sedan & Wagon Right Door\*+ .....ea .. 999.99
- SS-1000 .....1955-57 2-Door Hardtop & Convertible Door Weatherstripping with Correct Molded Ends .....pr ..... 69.99
- SS-1002 .....1955-57 Nomad Door Weatherstripping with Molded Ends .....pr ..... 59.99
- SS-1003 ..... 1955-57 2&4-Door Sedan & Station Wagon Door Weatherstripping.....pr ..... 39.99
- DWC-567 .....1955-57 Door Weatherstripping Fork Clips .....pr ..... 4.99
- SS-1204 .....1955-57 J-Shape Door Weatherstripping .....pr ..... 19.99
- CDOL-57 .....1955 & 1957 Left Complete Conv Door Shell\*+ .....ea .. 999.99
- CDOR-57 .....1955 & 1957 Right Complete Conv Door Shell\*+ .....ea .. 999.99
- HDOL-57 .....1955 & 1957 Left Complete 2-Door Hardtop Door Shell\*+ .....ea .. 999.99
- HDOR-57 ..... 1955 & 1957 Right Complete 2-Door Hardtop Door Shell\*+ .....ea .. 999.99
- DLAL-67 .....1956-57 4-Door Hardtop Used Left Front Door Latch Assembly .....ea .... 99.99
- DLAR-67 .....1956-57 4-Door Hardtop Used Right Front Door Latch Assembly .....ea .... 99.99
- DLL-67 .....1956-57 Left Door Latch .....ea .... 99.99
- DLR-67 .....1956-57 Right Door Latch.....ea .... 99.99
- SS-1004 .....1956-57 4-Door Hardtop Rear Door Weatherstripping with Molded Ends .....pr ..... 59.99
- SS-1005 .....1956-57 4-Door Hardtop Front Door Weatherstripping with Molded Ends .....pr ..... 59.99
- HCDL-56 .....1956 Left Complete 2-Door Hardtop & Convertible Door Shell with Bel Air Trim Holes\*+ .....ea .. 999.99
- HCDR-56.....1956 Right Complete 2-Door Hardtop & Convertible Door Shell with Bel Air Trim Holes\*+ .....ea .. 999.99
- FDGMC-567 1955-57 2-Door Hardtop & Convertible Front Door Garnish Molding Clips .....pr .....11.99
- 20-477A ..... 1955-57 4-Dr Rear Hinge & Tailgate Hinge Screws..set .....16.99
- IBAPH-567 ... 1955-57 2-Door Hardtop Inner Body Access Panel Covers Set of 6 .....set .....94.99
- IBAPS-567 .... 1955-57 2-Door Sedan Inner Body Access Panel Covers Set of 6 .....set .....94.99



**TRI-FIVE DOOR HANDLES**

- ODH-567.... 1955-57 Chrome Outside Door Handles ..... pr .....79.99
- DHG-56..... 1955-56 Chrome Accessory Door Handle Shields ..... pr .....29.99
- SS-1019 ..... 1955-57 Door Handle and Lock Gaskets ..... set..... 5.99
- SS-1020 ..... 1955-57 Door Handle, Door Lock, Trunk Lock , Antenna & Mirror Gaskets ..... set.....8.99
- SS-1021 ..... 1955-57 4-Door Door Handle, Door Lock, Trunk Lock, Antenna & Mirror Gaskets..... set.....11.99

**TRI-FIVE EXTERIOR MIRRORS**

- OSRVM-567 .....1955-57 Chrome Outside Door Mirror..... ea ..... 59.99
- OSRVMW-567 ....1955-57 Chrome Outside Door Mirror with Wide Angle Glass .....ea .... 59.99
- YRVM-567 .....“Yankee” Tri-Bar Chrome Outside Rear View Mirrors.....pr ....209.99

**1955-57 CHEVY 18-GAUGE STEEL OUTER ROCKER PANELS**



Real Deal Steel worked directly with the manufacturer to produce the most correct, best fitting rocker panels for Tri-5's available anywhere. Details like correct bottom vents, opening top access panels (just like GM!) along with forward end baffles and lower front fender brackets – all installed and ready to fix rust on your classic! Available for all body styles – 2-door hardtop/convertible/sedan/wagon/Nomad/Delivery, 4-door sedan and wagon, 1956-57 4-door hardtop.



**TRI-FIVE ROCKER PANELS**

- 554DLHR..... 1955 Left Factory Correct 4-Door Sedan & Station Wagon Rocker with Fender Bracket.....ea .. 189.99
- 554DRHR ..... 1955 Right Factory Correct 4-Door Sedan & Station Wagon Rocker with Fender Bracket.....ea .. 189.99
- 55LHR ..... 1955 All 2-Dr Left OE Correct Rocker w/Bracket.....ea .. 139.99
- 55RHR ..... 1955 All 2-Dr Right OE Correct Rocker w/Bracket...ea .. 139.99
- 1955-RPP..... 1955 Left & Right 2-Dr Factory Correct Rocker Panels pr ... 229.99
- RPM-55..... 1955 Stainless Steel Rocker Moldings with Clips...pr ... 199.99
- 567LIR..... 1955-57 Left Inner Rocker Panel .....ea .... 99.99
- 567RIR..... 1955-57 Right Inner Rocker Panel.....ea .... 99.99
- 2SDTRC-567 .. 1955-57 2-Dr Sedan Rear Wiring Trough Top Coverspr ..... 69.99
- 4DSTRC-567 .. 1955-57 4-Door Sedan & Wagon Rocker Panel Top Covers 4-Pc .....set .. 109.99
- RSP2-567..... 1955-57 2-Door Top of Rocker Panel Sill Covers..pr ..... 69.99
- 564DHLHR ..... 1956 Left Factory Correct 4-Door Hardtop/Sport Sedan Rocker Panel with Fender Bracket.....ea .. 199.99
- 564DHRHR..... 1956 Right Factory Correct 4-Door Hardtop/Sport Sedan Rocker Panel with Fender Bracket.....ea .. 199.99
- 56LHR ..... 1956 All 2-Dr Left OE Correct Rocker w/Bracket.....ea .. 139.99
- 56RHR ..... 1956 All 2-Dr Right OE Correct Rocker w/Bracket...ea... 139.99
- 1956-RPP..... 1956 Left & Right 2-Dr Factory Correct Rocker Panels pr ... 229.99
- RPM-56..... 1956 Stainless Steel Rocker Moldings with Clips...pr ... 199.99
- 4DHTRC-67.... 1956-57 4-Door Hardtop Rocker Panel Top Covers 4-Pc .....set .. 139.99
- 574DHLHR ..... 1957 Left Factory Correct 4-Door Hardtop/Sport Sedan Rocker with Fender Bracket.....ea .. 199.99
- 574DHRHR..... 1957 Right Factory Correct 4-Door Hardtop/Sport Sedan Rocker with Fender Bracket.....ea .. 199.99
- 574DLHR..... 1957 Left Factory Correct 4-Door Sedan & Station Wagon Rocker with Fender Bracket.....ea .. 199.99
- 574DRHR ..... 1957 Right Factory Correct 4-Door Sedan & Station Wagon Rocker with Fender Bracket.....ea .. 199.99
- 57LHR ..... 1957 All 2-Dr Left Factory Correct Rocker w/Bracket ea .. 139.99
- 57RHR ..... 1957 All 2-Dr Right Factory Correct Rocker with Bracket.....ea... 139.99
- 1957-RPP..... 1957 Left & Right 2-Dr Factory Correct Rocker Panels pr ... 229.99
- RPM-57..... 1957 Stainless Steel Rocker Moldings with Clips...pr ... 229.99



**TRI-FIVE DOOR SILL PLATES**

- DSP2-567 ... 1955-57 2-Door Body by Fisher Sill Plates .....pr ..... 59.99
- DSP4-567 ... 1955-57 4-Door Sedan & Station Wagon Body by Fisher Sill Plates .....pr ..... 89.99
- SPSS-567 .... 1955-57 2-Door Stainless Steel Bowtie Sill Plates .....pr ..... 94.99
- MH-61..... 1956-57 4-Door Hardtop Sill Plates.....pr ... 224.99

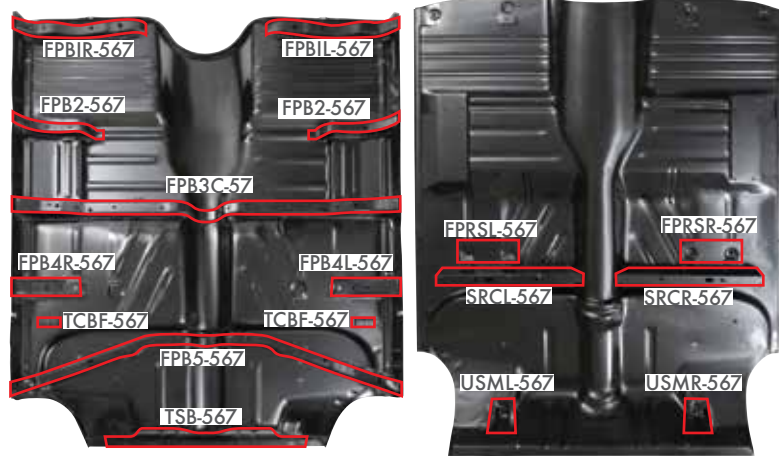

**TRI-FIVE FLOOR PANS**



- HTFF-567DEL .... 1955-57 2-Door Hardtop Fully Welded Floor w/Braces & Spare Tire Delete Trunk Floor\* ..... ea ... 2204.99
- SRL-567 ..... 1955-57 2-Door Hardtop Left Rear Seat Riser ..... ea ..... 94.99
- SRR-567..... 1955-57 2-Door Hardtop Right Rear Seat Riser..... ea ..... 94.99
- SRSFP-567 ... 1955-57 2&4-Door Sedan, 1956-57 4-Door Hardtop Rear Seat Floor Pockets..... pr..... 49.99
- SDFF-567 .... 1955-57 2&4-Door Sedan Fully Welded Floor with Braces and Trunk Floor\* ..... ea ... 2204.99
- SDFF-567DEL .... 1955-57 2&4-Door Sedan Fully Welded Floor w/Braces & Spare Tire Delete Trunk Floor\* ..... ea ... 2204.99
- CSF1-567.... 1955-57 Sedan, Wagon, Nomad Full Floor with Braces\* ..... ea ..... 999.99
- FPB3-567 .... 1955-57 Long Floor Brace Under Front Seat All Except Convertible & 4-Door Hardtop..... ea ..... 199.99
- 11-098..... 1955-57 Long Rear Floor Brace Left End..... ea ..... 78.99
- 11-099..... 1955-57 Long Rear Floor Brace Right End ..... ea ..... 78.99
- BSFPL-567 ... 1955-57 Left Beside Front Seat Floor Repair Panel.. ea ..... 49.99
- BSFPR-567 ... 1955-57 Right Beside Front Seat Floor Repair Panelea ..... 49.99
- FFPL-567 .... 1955-57 Left Front Floor Panel..... ea ..... 79.99
- FFPR-567 .... 1955-57 Right Front Floor Panel ..... ea ..... 79.99
- FPB1L-567... 1955-57 Left Front Floor Brace ..... ea ..... 74.99
- FPB1R-567... 1955-57 Right Front Floor Brace ..... ea ..... 74.99
- FPB2-567 .... 1955-57 Forward Floor Seat Brace (L or R) ..... ea ..... 49.99
- FPB3E-567 .. 1955-57 Center Long Floor Brace Ends Only..... pr ..... 89.99
- FPB5-567 .... 1955-57 Long Rear Floor Brace in Front of Wheel Wells..... ea ..... 199.99
- FPHL-567 .... 1955-57 Sedan&Wagon Left Half Floor Pan Full\*... ea ..... 269.99
- FPHHL-567.. 1955-57 Hardtop & Conv Left Half Floor Pan Full\*. ea ..... 269.99
- FPHR-567 .... 1955-57 Sedan&Wagon Rht Half Floor Pan Full\* ... ea ..... 269.99
- FPHHR-567 . 1955-57 Hardtop & Conv Right Half Floor Pan Full\* . ea ..... 269.99
- FPRL-567 ..... 1955-57 Left Rear Floor Pan ..... ea ..... 89.99
- FPRR-567 ..... 1955-57 Right Rear Floor Pan ..... ea ..... 89.99
- FPURL-567 .. 1955-57 Left Rear Under Seat Floor Pan ..... ea ..... 84.99
- FPURR-567 .... 1955-57 Right Rear Under Seat Floor Pan..... ea ..... 84.99

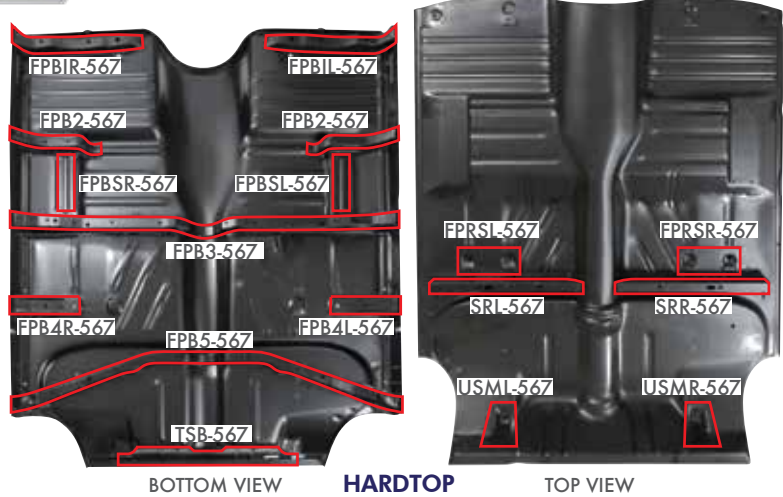
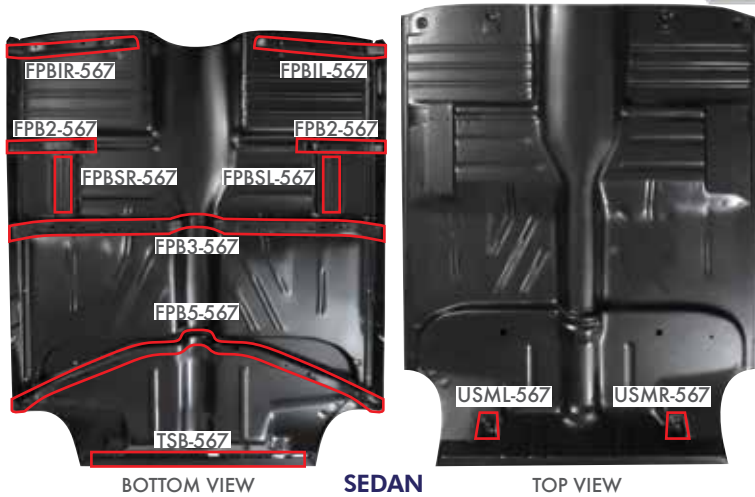

**TRI-FIVE FLOOR PANS**

LHTB-567	..... 1955-57 Left Toeboard Panel.....	ea	..... 78.99
RHTB-567	..... 1955-57 Right Toeboard Panel .....	ea	..... 78.99
MFPL-567	..... 1955-57 Left Front Under Seat Floor Pan.....	ea	..... 71.99
MFPR-567	..... 1955-57 Right Front Under Seat Floor Pan.....	ea	..... 71.99
USML-567	..... 1955-57 Left Rear Underseat Body Mount Reinforcement.....	ea	..... 69.99
USMR-567	..... 1955-57 Right Rear Underseat Body Mount Reinforcement.....	ea	..... 69.99
SRFBL-567	..... 1955-57 Station Wagon and Nomad Left Rear Seat to Floor Mount .....	ea	..... 89.99
SRFBR-567	..... 1955-57 Station Wagon and Nomad Right Rear Seat to Floor Mount .....	ea	..... 89.99
FPBSL-567	..... 1955-57 Left Flat Seat Brace Under Floor .....	ea	..... 59.99
FPBSR-567	..... 1955-57 Right Flat Seat Brace Under Floor.....	ea	..... 59.99
SWFF-567	..... 1955-57 2&4-Door Wagon & Nomad Fully Welded Floor with Braces and Complete Cargo Floor* .....	ea	..... 2899.99
TBP-56	..... 1955-56 Left & Right Toeboard w/Tunnel Section ..	ea	..... 359.99
4DHTFF-67	..... 1956-57 4-Door Hardtop Fully Welded Floor with Braces and Trunk Floor*.....	ea	..... 2499.99
4HTF-67	..... 1956-57 4-Dr Hardtop Full Floor with Braces* .....	ea	..... 1399.99
HT4B-67	..... 1956-57 4-Dr Hardtop Main Floor Center Brace .....	ea	..... 389.99
TBP-57	..... 1957 Left & Right Toeboard Panel w/Tunnel Section ..	ea	..... 359.99
CBL-567	..... 1955 All & 1956-57 Convertible Left Inner Cowl to Floor Brace .....	ea	..... 109.99
CBR-567	..... 1955 All & 1956-57 Convertible Right Inner Cowl to Floor Brace .....	ea	..... 109.99

**TRI-FIVE FLOOR PANS**

CVT-RSB1	..... 1955-57 Convertible Rear Seat Floor Bracket.....	ea	..... 24.99
CVF1-567	..... 1955-57 Convertible Full Floor with Braces* .....	ea	..... 999.99
CVTFF-567	..... 1955-57 Convertible Fully Welded Floor with Braces and Trunk Floor*.....	ea	..... 2099.99
FPB3C-567	..... 1955-57 Convertible Long Floor Brace Under Front Seat .....	ea	..... 254.99
TCBF-567	..... 1955-57 Convertible Rear Floor Top Cylinder Bracket Plate (2 Required) .....	ea	..... 41.99
SRCL-567	..... 1955-57 Convertible Left Rear Seat Riser .....	ea	..... 84.99
SRCR-567	..... 1955-57 Convertible Right Rear Seat Riser .....	ea	..... 84.99
FPB4L-567	..... 1955-57 2-Door Hardtop & Convertible Left Floor Brace Behind B-Pillar .....	ea	..... 59.99
FPB4R-567	..... 1955-57 2-Door Hardtop & Convertible Right Floor Brace Behind B-Pillar .....	ea	..... 59.99
FPRSL-567	..... 1955-57 2-Door Hardtop & Convertible Left Rear Floor Pan Forward Seat Reinforcement .....	ea	..... 69.99
FPRSR-567	..... 1955-57 2-Door Hardtop & Convertible Right Rear Floor Pan Forward Seat Reinforcement .....	ea	..... 69.99
HTF1-567	..... 1955-57 2-Dr Hardtop Complete Floor w/Braces* .....	ea	..... 999.99
HTFF-567	..... 1955-57 2-Door Hardtop Fully Welded Floor with Braces and Trunk Floor*.....	ea	..... 2204.99

**1955-57 CHEVY ENLARGED TRANSMISSION TUNNEL FOR LATE MODEL TRANSMISSIONS**

Finally, a solution for the installation of the GM 6L80, 6L90 and Tremec T-56 transmissions. These popular transmissions are often coupled to LS engines and create some major clearance issues with the original transmission tunnel. Ours are a full 2" larger to allow transmission installation without lowering the gage member and changing the driveline angle. Made in the USA using 16-gauge steel, they are available for use with stock firewalls or our 4" recessed firewalls. Also available as an upgrade on any of our 55-57 bodies!



6LT-567	..... 1955-57 Enlarged Transmission Tunnel for Use with Recessed Firewall.....	ea	..... 399.99
6LTS-567	..... 1955-57 Enlarged Transmission Tunnel for Use with Stock Firewall.....	ea	..... 399.99

**TRI-FIVE TRANSMISSION TUNNEL**

INSP-567	..... 1955-57 Toeboard Tunnel Inspection Cover .....	ea	..... 39.99
TRT-567	..... 1955-57 Transmission Tunnel.....	ea	..... 104.99



**1955-57 CHEVY FULLY WELDED FLOOR & TRUNK FLOOR NARROWED FOR WIDER WHEEL TUBS**

If you plan to replace the original floor and trunk floor in your Tri-5 anyway, and you want to utilize a wider wheel and tire out back, consider one of our pre-assembled floors. Carefully fixture welded on the very same platform we use to assemble or complete steel car bodies, the trunk floor and main floor spot welded together then cut and fitted to accept our wider wheel tubs WWT-567 and a 12" wide wheel with a 335mm tire. Also available as an upgrade on any of our 55-57 bodies!



CVTFF-567-WWT	..... 1955-57 Conv Welded Floor with Braces & Spare Tire Delete Trunk Floor Narrowed for Wider Wheel Tub* .....	ea	..... 2399.99
HTFF-567-WWT	..... 1955-57 2-Dr Hardtop Fully Welded Floor with Braces & Spare Tire Delete Trunk Floor Narrowed for Wider Wheel Tub* .....	ea	..... 2519.99
SDF-567-WWT	..... 1955-57 2&4-Dr Sedan Fully Welded Floor with Braces & Spare Tire Delete Trunk Floor Narrowed for Wider Wheel Tub* .....	ea	..... 2519.99



**TRI-FIVE INNER QUARTER PANELS**

- IQPCL-567 .....1955-57 Convertible Left Inner Quarter Panel Complete\*+ ..... ea..... 999.99
- IQPCR-567 .....1955-57 Convertible Right Inner Quarter Panel Complete\*+ ..... ea..... 999.99
- IQPHL-567 .....1955-57 2-Door Hardtop Left Inner Quarter Panel Complete\*+ .....ea..... 999.99
- IQPHR-567 .....1955-57 2-Door Hardtop Right Inner Quarter Panel Complete\*+ .....ea..... 999.99
- IQPHLT-567 .....1955-57 2-Door Hardtop Mini-Tubbed Left Inner Quarter Panel Complete\*+ .....ea..... 999.99
- IQPHRT-567 .....1955-57 2-Door Hardtop Mini-Tubbed Right Inner Quarter Panel Complete\*+ .....ea..... 999.99
- IQPSL-567 .....1955-57 2-Door Sedan Left Inner Quarter Panel Complete\*+ .....ea..... 999.99
- IQPSR-567 .....1955-57 2-Door Sedan Right Inner Quarter Panel Complete\*+ .....ea..... 999.99
- IQPSLT-567 .....1955-57 2-Door Sedan Mini-Tubbed Left Inner Quarter Panel Complete\*+ .....ea..... 999.99
- IQPSRT-567 .....1955-57 2-Door Sedan Mini-Tubbed Right Inner Quarter Panel Complete\*+ .....ea..... 999.99
- 11-2058 .....1955-57 2-Door Sedan Left Rear Inner Quarter Access Cover..... ea..... 41.99
- 11-2059 .....1955-57 2-Door Sedan Right Rear Inner Quarter Access Cover..... ea..... 41.99
- WWWL-567 .....1955-57 Station Wagon & Nomad Left Rear Inner Wheel Well.....ea..... 319.99
- WWWR-567 .....1955-57 Station Wagon & Nomad Right Rear Inner Wheel Well.....ea..... 319.99

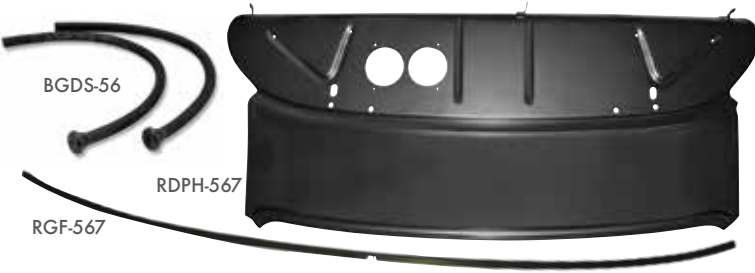

**TRI-FIVE DECK FILLER/PACKAGE TRAY**

- RDFC-567 ....1955-57 Convertible Rear Deck Filler Panel .....ea..... 129.99
- RDFUC-567 ..1955-57 Convertible Rear Deck Filler Inner Brace .. ea..... 299.99
- RDPH-567 ....1955-57 2-Door Hardtop Rear Package Tray/Deck Filler Panel.....ea..... 349.99
- RGF-567 .....1955-57 Rear Window Gasket Channel Flange .....ea..... 84.99
- RPTS-567 .....1955-57 2&4-Door Sedan Rear Package Tray/Deck Filler Panel.....ea..... 359.99
- BGDS-56 .....1955-56 2&4-Door Sedan Back Glass Drain Seals and Tubes.....pr ..... 15.99
- BGDS-57 .....1956-57 4-Door Hardtop & 1957 2&4-Door Sedan Back Glass Drain Seals and Tubes .....pr ..... 15.99



**TRI-FIVE WHEELHOUSE**

- FWHLS-55 ....1955 2-Door Sedan & Station Wagon/Nomad Left Forward Outer Wheelhouse Panel ..... ea .. 104.99
- FWHRS-55 ....1955 2-Door Sedan & Station Wagon/Nomad Right Forward Outer Wheelhouse Panel ..... ea .. 104.99
- MWSL-55 .....55 2-Dr Sedan Left Middle Outer Wheelhouse Panel.ea..... 89.99
- MWSR-55 .....55 2-Dr Sedan Right Middle Outer Wheelhouse Panel ea..... 89.99
- WEXL-5 .....1955 Left Rear Wheelhouse Extension Panel .....ea..... 49.99
- WEXR-5 .....1955 Right Rear Wheelhouse Extension Panel.....ea..... 49.99
- WHPCL-55 ...1955 Conv Left Rear Outer Wheelhouse Complete...ea..... 189.99
- WHPCR-55 ...1955 Conv Right Rear Outer Wheelhouse Complete..ea..... 189.99
- WHPHL-55 ...55 2-Dr Hardtop Lt Rear Outer Wheelhouse Complete.. 189.99
- WHPHR-55 ...55 2-Dr Hardtop Rt Rear Outer Wheelhouse Complete . 189.99
- WHPSL-55 ....1955 2-Dr Sedan LR Outer Wheelhouse Complete...ea..... 189.99
- WHPSR-55 ....1955 2-Dr Sedan RR Outer Wheelhouse Complete ..ea..... 189.99
- OWHS-567 ...1955-57 Rear Outer Wheelhouse Rubber Seals .....set ..... 39.99
- FWHLH-567 ..55-57 2-Dr Hardtop Lt Forward Outer Wheelhouse Panel... 94.99
- FWHRH-567 ..55-57 2-Dr Hardtop Rt Forward Outer Wheelhouse Panel... 94.99
- FWHL-67 .....1956-57 Station Wagon & Nomad Left Forward Outer Wheelhouse Panel .....ea..... 114.99
- FWHR-67 .....1956-57 Station Wagon & Nomad Right Forward Outer Wheelhouse Panel .....ea..... 114.99
- FWHLS-67 ....1956-57 2-Dr Sedan Left Forward Wheelhouse Panel ..ea..... 114.99
- FWHRS-67 ....1956-57 2-Dr Sedan Right Forward Wheelhouse Panel..ea..... 114.99
- FWCLH-567 ....1955-57 Conv Left Forward Outer Wheelhouse Panel..ea..... 104.99
- FWCRH-567 ...1955-57 Conv Right Forward Outer Wheelhouse Panel .ea..... 104.99
- MWCHL-567 ...1955-57 2-Door Hardtop & Convertible Left Middle Outer Wheelhouse Panel ..... ea.....73.99
- MWCHR-567 ...1955-57 2-Door Hardtop & Convertible Right Middle Outer Wheelhouse Panel .....ea.....73.99
- MWSL-67 .....56-57 2-Dr Sedan Left Middle Outer Wheelhouse.ea..... 104.99
- MWSR-67 .....56-57 2-Dr Sedan Right Middle Outer Wheelhouse..ea..... 104.99
- MWHL-67 .....1956-57 Station Wagon & Nomad Left Middle Outer Wheelhouse Panel .....ea..... 104.99
- MWHR-67 .....1956-57 Station Wagon & Nomad Right Middle Outer Wheelhouse Panel .....ea..... 104.99
- RWHL-67 .....1956-57 Station Wagon & Nomad Left Rear Outer Wheelhouse Panel "Mud Flap" .....ea..... 62.99
- RWHR-67 .....1956-57 Station Wagon & Nomad Right Rear Outer Wheelhouse Panel "Mud Flap" .....ea..... 62.99
- WEXL-67 .....1956-57 Left Rear Wheelhouse Extension Panel .....ea..... 69.99
- WEXR-67 .....1956-57 Right Rear Wheelhouse Extension Panel ... ea..... 69.99
- WHPCL-67 ...1956-57 Conv Left Rear Outer Wheelhouse Complete ea..... 189.99
- WHPCR-67 ...1956-57 Conv Right Rear Outer Wheelhouse Complete ea..... 189.99
- WHPHL-67 ...56-57 2-Dr Hardtop Left Rear Outer Wheelhouse Complete . 189.99
- WHPHR-67 ...56-57 2-Dr Hardtop Right Rear Outer Wheelhouse Complete 189.99
- WHPSL-67 ....56-57 2-Dr Sedan Lt Rear Outer Wheelhouse Complete . 189.99
- WHPSR-67 ....56-57 2-Dr Sedan Rt Rear Outer Wheelhouse Complete.. 189.99

**TRI-FIVE TAILPAN**



- TPB-567 .....1955-57 Tailpan Support Brace.....ea..... 169.99
- TPK-567 .....1955-57 Non-Wagon Tailpan, Last 10" Trunk Floor & Tailpan Brace 3-Pieces.....kit ..... 359.99
- TPNW-567 ....1955-57 Non-Wagon Tailpan .....ea..... 104.99
- TPSW-567 .....1955-57 Wagon, Sedan Delivery & Nomad Tailpan ..ea..... 159.99
- TPSWB-567 ..1955-57 Station Wagon, Nomad & Sedan Delivery Tailpan Support Brace (2 Required).....ea..... 48.99
- CFT-567 .....1955-57 Sedan Delivery Rear Cargo Floor Extension Under Tailpan .....ea..... 199.99
- CFTW-567 ....1955-57 Station Wagon & Nomad Rear Cargo Floor Extension Under Tailpan.....ea..... 397.99

**REAL DEAL STEEL:**

1220 East 30th Street | Sanford, FL 32773  
Tel: 407-585-1957 | [www.realdealsteel.com](http://www.realdealsteel.com)



1955 & 1957 FULL QUARTER PANELS

There are several Tri-5 "full" quarter panels on the market, but some of them are not "full"! Our full panels are made in one piece just like GM made them. They include the complete door jamb area, upper extension to trunk lid & the trunk trough! Others may include just the face skin which requires extensive cutting & welding along non-factory seams. Our full panels install right at the factory seams!

TRI-FIVE QUARTER PANELS

GQP-55.....	1955 "Gasser" Radiussed Quarter Panel inserts ....pr.....	189.99
LRQP-55.....	1955 2-Dr Lt Rear Lower Qtr Panel Repair Panel ...ea.....	129.99
RRQP-55.....	1955 2-Dr Rt Rear Lower Qtr Panel Repair Panel ....ea.....	129.99
AQPL-55.....	1955 Left Full Lower Quarter Panel*.....ea.....	594.99
AQPR-55.....	1955 Right Full Lower Quarter Panel*.....ea.....	594.99
QPPL-55.....	1955 2-Door Left Lower Forward Quarter Panel Section.....ea.....	169.99
QPPR-55.....	1955 2-Door Right Lower Forward Quarter Panel Section.....ea.....	169.99
QPBB-55.....	1955 Rear Quarter Panel to Rear Bumper Reinforcement Plates.....ea.....	41.99
QPBF-55.....	1955 Quarter Panel to Bumper End Filler Panels...pr.....	54.99
NQPL-55.....	1955 Nomad Left Quarter Panel*.....ea.....	974.99
NQPR-55.....	1955 Nomad Right Quarter Panel*.....ea.....	974.99
QPSH-567....	1955-57 Bel Air 2-Door Hardtop Restored Quarter Window Sail Panel Dogleg Stainless.....pr.....	599.99
QPTPL-55.....	1955-56 Conv Left Qtr Panel to Trunk Top Panel ...ea.....	299.99
QPTPR-55.....	1955-56 Conv Right Qtr Panel to Trunk Top Panel .ea.....	299.99
QPCNSL-56 .	1956 2-Door Hardtop & Convertible Left Quarter Panel Skin - NO Trim Holes*.....ea.....	849.99
QPCNSR-56 .	1956 2-Door Hardtop & Convertible Right Quarter Panel Skin - NO Trim Holes*.....ea.....	849.99
QPCSL-56 ....	1956 2-Door Hardtop & Convertible Left Quarter Panel Skin with Holes*.....ea.....	879.99
QPCSR-56 ....	1956 2-Door Hardtop & Convertible Right Quarter Panel Skin with Holes*.....ea.....	879.99
QPPL-56.....	1956 2-Dr Left Lower Forward Quarter Panel Section.....ea.....	179.99
QPPR-56.....	1956 2-Dr Right Lower Forward Quarter Panel Section.....ea.....	179.99
LRQP-57.....	1957 2-Dr Left Rear Lower Qtr Panel Repair Panel .ea.....	159.99
RRQP-57.....	1957 2-Dr Right Rear Lower Qtr Panel Repair Panel .ea.....	159.99
QPPL-57.....	1957 2-Dr Left Lower Forward Quarter Panel Section...ea.....	179.99
QPPR-57.....	1957 2-Dr Right Lower Fwd Qtr Panel Section.....ea.....	179.99
QPTPL-57.....	1957 Conv Left Quarter Panel to Trunk Top Panel..ea.....	299.99
QPTPR-57.....	1957 Conv Right Quarter Panel to Trunk Top Panel...ea.....	299.99

QPC-55L.....	1955 Left Full Convertible Quarter Panel with Door Jamb and Trunk Gutter*+.....ea ..	1299.99
QPC-55R.....	1955 Right Full Convertible Quarter Panel with Door Jamb and Trunk Gutter*+.....ea ..	1299.99
QPH-55L.....	1955 Left Full Hardtop Quarter Panel with Door Jamb and Trunk Gutter*+.....ea ..	1299.99
QPH-55R.....	1955 Right Full Hardtop Quarter Panel with Door Jamb and Trunk Gutter*+.....ea ..	1299.99
SQPL-55.....	1955 Left Full 2-Door Sedan Quarter Panel*+.....ea ..	1299.99
SQPR-55.....	1955 Right Full 2-Door Sedan Quarter Panel*+ ..ea ..	1299.99
SQPP-55.....	1955 Left & Right Full 2-Door Sedan Quarter Panels Pair*.....pr.....	2199.99
QPPC-55.....	1955 Left & Right Full Convertible Quarter Panels Pair*.....pr.....	2199.99
QPPH-55.....	1955 L & R Full Hardtop Quarter Panels Pair*.....pr.....	2199.99
QPC-56L.....	1956 Left Full Convertible Quarter Panel with Door Jamb and Trunk Gutter*.....ea ..	1299.99
QPC-56R.....	1956 Right Full Convertible Quarter Panel with Door Jamb and Trunk Gutter*.....ea ..	1299.99
QPH-56L.....	1956 Left Full 2-Door Hardtop Quarter Panel with Door Jamb and Trunk Gutter*.....ea ..	1299.99
QPH-56R.....	1956 Right Full 2-Door Hardtop Quarter Panel with Door Jamb and Trunk Gutter*.....ea ..	1299.99
QPPH-56.....	1956 Left & Right Full 2-Door Hardtop Quarter Panels Pair*.....pr.....	2199.99
QPPC-56.....	1956 L & R Full Convertible Quarter Panels Pair*.....pr.....	2199.99
QPC-57L.....	1957 Left Full Convertible Quarter Panel with Door Jamb and Trunk Gutter*+.....ea ..	1299.99
QPC-57R.....	1957 Right Full Convertible Quarter Panel with Door Jamb and Trunk Gutter*+.....ea ..	1299.99
QPH-57L.....	1957 Left Full Hardtop Quarter Panel with Door Jamb and Trunk Gutter*.....ea ..	1299.99
QPH-57R.....	1957 Right Full Hardtop Quarter Panel with Door Jamb and Trunk Gutter*.....ea ..	1299.99
SQPL-57.....	1957 Left Full 2-Door Sedan Quarter Panel*.....ea ..	1299.99
SQPR-57.....	1957 Right Full 2-Door Sedan Quarter Panel*.....ea ..	1299.99
574HTQPL.....	1957 4-Door Hardtop Left Quarter Panel*.....ea.....	469.99
574HTQPR.....	1957 4-Door Hardtop Right Quarter Panel*.....ea.....	469.99
QPPC-57.....	1957 Left & Right Full Convertible Quarter Panels Pair*.....pr.....	2199.99
QPPH-57.....	1957 Left & Right Complete 2-Door Hardtop Quarter Panels Pair*.....pr.....	2199.99

1955-57 TIPS FROM THE GARAGE

Battle of the Bulge - When installing a reproduction

Tri-5 quarter panel, it is difficult to obtain that nice, flat surface on the quarter panel behind the door & the over the wheel opening. The new quarters have a tendency to "bulge" which creates a serious challenge when it comes time to do final bodywork.



1. Don't force the bottom of the quarter up to match the inner rocker if it hangs down. Doing so increases the bulge. If needed, use your cutoff wheel & score a line (no need to cut all the way through) at the bottom radius of the quarter so it can be pushed into shape without causing the outer panel to bulge.
2. Raise the rear of the quarter up before securing it to the trunk opening area. Pull up on the quarter at the rear, you will see the bulge lessen dramatically.
3. Pull the panel inboard using a strap and Vice Grips in the wheel opening, cut some pie-slots in the inner wheel opening flange and re-weld. This will help flatten the face of the quarter between the door opening and the wheel opening.



## TRI-FIVE TRUNK

TAK-567	..... 1955-57 Trunk Alignment.....	kit	..... 64.99
TS-567	..... 1955-57 Trunk Striker.....	ea	..... 29.99
20-010S	..... 1955-57 Trunk Striker Bolts.....	pr	..... 6.99
20-011	..... 1955-57 Trunk Latch Bolts (8).....	set	..... 4.99
20-012S	..... 1955-57 Trunk Lid to Hinge Bolts (4).....	set	..... 17.99
20-253A	..... 1955-57 Spare Tire Wingnut.....	ea	..... 12.99
20-368	..... 1955-57 Spare Tire Holddown Bolt.....	ea	..... 8.99
20-329	..... 1955-57 Station Wagon & Nomad Spare Tire Holddown Bolt.....	ea	..... 5.99
ATF1	..... 1955-57 All Except Conv Trunk Floor w/Braces*.....	ea	..... 899.99
CTF1-567	..... 1955-57 Convertible Trunk Floor with Braces*.....	ea	..... 899.99
CTFBP-567	..... 1955-57 Convertible Upper Trunk Floor Body Mount Braces.....	pr	..... 69.99
NTF-567	..... 1955-57 Trunk Floor for Wider Wheel Well Tubs*.....	ea	..... 999.99
RTM-567	..... 1955-57 Rubber Trunk Mat.....	ea	..... 139.99
RTMC-567	..... 1955-57 Convertible Rubber Trunk Mat.....	ea	..... 139.99
RTMD-567	..... 1955-57 Spare Tire Delete Rubber Trunk Mat.....	ea	..... 139.99
LIQPP-567	..... 1955-57 2-Door Hardtop & Convertible Left Inner Trunk Wall Repair Panel.....	ea	..... 289.99
RIQPP-567	..... 1955-57 2-Door Hardtop & Convertible Right Inner Trunk Wall Repair Panel.....	ea	..... 289.99
LLQPP-567	..... 1955-57 2-Door Hardtop & Convertible Left Lower Inner Trunk Wall Repair Panel.....	ea	..... 62.99
RLQPP-567	..... 1955-57 2-Door Hardtop & Convertible Right Lower Inner Trunk Wall Repair Panel.....	ea	..... 62.99
LSTF-567	..... 1955-57 Left Side Trunk Floor Repair Panel.....	ea	..... 84.99
RSTF-567	..... 1955-57 Right Side Trunk Floor Repair Panel.....	ea	..... 84.99
TCRL-567	..... 1955-57 Left Rear Inner Trunk Wall Repair Panel.....	ea	..... 36.99
TCRR-567	..... 1955-57 Right Rear Inner Trunk Wall Repair Panel.....	ea	..... 36.99
TF10-567	..... 1955-57 Last 10" Trunk Floor Repair Panel.....	ea	..... 129.99
TFSTB-567	..... 1955-57 Trunk Floor Lower Striker Bracket.....	ea	..... 69.99
TFJBS-567	..... 1955-57 Trunk Floor Striker & Jack Brackets.....	set	..... 69.99
TFK-WWT-567	..... 1955-57 Wider Trunk Wheel Well Tubs & Pre-Narrowed Trunk Floor*.....	kit	..... 1299.99
TLHH-567	..... 1955-57 2-Door Hardtop Trunk Hinges.....	pr	..... 274.99
THC-567	..... 1955-57 Convertible Trunk Hinges.....	pr	..... 274.99
THS-567	..... 1955-57 Sedan Trunk Hinges.....	pr	..... 274.99
TLC-567	..... 1955-57 Trunk Latch Cover on Deck Lid.....	ea	..... 29.99
TSB-567	..... 1955-57 Trunk Reinforcement.....	ea	..... 74.99
TTR-567	..... 1955-57 Trunk Hinge Torsion Rods.....	pr	..... 144.99
SNB-567	..... 1955-57 Under Rear Floor Rubber Snubber Bracket.....	ea	..... 54.99
SS-6012	..... 1955-56 Trunk Weatherstripping.....	ea	..... 42.99

TL-56	..... 1955-56 Trunk Lid*.....	ea	..... 599.99
TLA-567	..... 1957 Trunk Latch Assembly.....	ea	..... 129.99
SS-1011	..... 1957 Trunk Weatherstripping.....	ea	..... 26.99
TL-57	..... 1957 Trunk Lid*.....	ea	..... 599.99
V8G-57	..... 1957 V8 Gold Hood or Trunk Script.....	ea	..... 34.99
V8S-57	..... 1957 V8 Chrome Hood or Trunk Script.....	ea	..... 34.99
TLTK1-57	..... 1957 Aluminum Deck Lid Trim 3-Piece.....	kit	..... 184.99
STF1-567	..... 1955-57 Smooth Style Spare Tire Delete Trunk Floor with Braces*.....	ea	..... 899.99
STF2-567	..... 1955-57 Trunk Floor No Braces or Tire Well*.....	ea	..... 474.99
STW-567	..... 1955-57 Non-Wagon Spare Tire Well.....	ea	..... 124.99
SPWD-567	..... 1955-57 Non-Wagon Spare Tire Well Delete Panel.....	ea	..... 39.99
TP1024	..... 1955 Trunk Emblem Assembly.....	ea	..... 79.99
RTV-56	..... 1956 Chrome Trunk V.....	ea	..... 54.99
TP1394	..... 1956 6-Cylinder Trunk Emblem Assembly.....	ea	..... 124.99
TP1306	..... 1956 V8 Trunk Emblem Assembly.....	ea	..... 59.99
RTV-57	..... 1957 Chrome Trunk V.....	ea	..... 119.99
RVG-57	..... 1957 Gold Trunk V.....	ea	..... 119.99
TIM-567	..... 1955-57 Trunk Lid Insulation.....	kit	..... 34.99

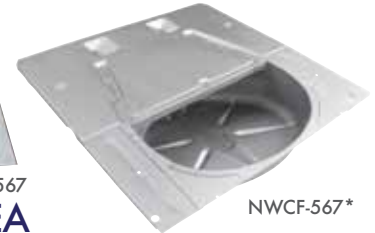

## TRI-FIVE CARGO AREA

NWCF-567	..... 1955-57 Nomad & Station Wagon Complete Rear Cargo Floor*.....	ea	..... 1599.99
NWCFNS-567	..... 1955-57 Nomad & Station Wagon Complete Rear Cargo Floor Less Spare Tire Well*.....	ea	..... 989.99
WCF-567	..... 1955-57 Station Wagon/Nomad/Sedan Delivery Rear Cargo Floor with Braces.....	ea	..... 799.99
WCFNB-567	..... 1955-57 Station Wagon/Nomad/Sedan Delivery Rear Cargo Floor without Braces.....	ea	..... 179.99
WSTW-567	..... 1955-57 Station Wagon, Nomad & Sedan Delivery Spare Tire Well.....	ea	..... 259.99
CFB-567	..... 1955-57 Station Wagon, Sedan Delivery & Nomad Rear Cargo Floor Brace.....	ea	..... 199.99
CFBS-567	..... 1955-57 Station Wagon & Nomad Rear Cargo Floor Support Brace & Baffle.....	set	..... 234.99
CFEL-567	..... 1955-57 Station Wagon, Nomad & Sedan Delivery Left Rear Cargo Floor Extension.....	ea	..... 69.99
CFER-567	..... 1955-57 Station Wagon, Nomad & Sedan Delivery Right Rear Cargo Floor Extension.....	ea	..... 69.99
CFSBL-567	..... 1955-57 Station Wagon, Sedan Delivery & Nomad Left Rear Cargo Floor Shock Brace.....	ea	..... 89.99
CFSBR-567	..... 1955-57 Station Wagon, Sedan Delivery & Nomad Right Rear Cargo Floor Shock Brace.....	ea	..... 89.99
CFT-567	..... 1955-57 Sedan Delivery Rear Cargo Floor Extension Under Tailpan.....	ea	..... 199.99
CFTW-567	..... 1955-57 Station Wagon & Nomad Rear Cargo Floor Extension Under Tailpan.....	ea	..... 397.99
SWNCF-567	..... 1955-57 Station Wagon & Nomad Cargo Floor/Spare Tire Well Brace & Filler.....	kit	..... 129.99
SWNFF-567	..... 1955-57 Station Wagon & Nomad Cargo Spare Tire Well Delete Panel.....	ea	..... 99.99
TPSWB-567	..... 1955-57 Station Wagon, Nomad & Sedan Delivery Tailpan Support Brace (2 Required).....	ea	..... 48.99

## 1955-57 CHEVY MINI-TUBS

Developed by Real Deal Steel nearly ten years ago, this popular conversion has brought thousands of Tri-5's into the modern pro-touring era!

The original narrow tubs only allow for up to an 8" wheel and maximum 275mm tire. With our mini-tubs and some rear suspension mods, you can utilize a 12" wheel and a big 335mm of rubber! Mini-tubs fit all non-wagons and are also available pre-installed on our hardtop and sedan inner quarters. Also available as an upgrade on any of our 55-57 bodies!



WWT-567	..... 1955-57 Mini-Tubs.....	pr	..... 489.99
---------	------------------------------	----	--------------



TGTSSW-567



CDLR-567

MH-315

**1955-57 CHEVY  
NOMAD (ALSO  
PONTIAC SAFARI)  
COMPLETE TAILGATE**



Since introduced, our Nomad complete tailgate assembly has prevented owners from having to repair badly rusted originals or pay through the nose for rust-free originals. We test fit, made corrections and test fit again until we could get the best fitting part possible. Complete inner and outer structure with all proper mount locations, latch and cover points. A beautiful reproduction steel part!

TGN-567.....1955-57 Nomad Complete Tailgate\* ..... ea .. 1199.99



TGLN-567

TGCS-567



TGHCW-567

TGT-567

**TRI-FIVE TAILGATE/LIFTGATE**

- TGT-567 .....1955-57 Wagon & Nomad Tailgate Hinge Trim.... pr..... 74.99
- TGHCN-567 1955-57 Nomad Tailgate Hinge Covers on Body . pr ..... 79.99
- TGHCW-567 1955-57 Wagon Tailgate Hinge Covers on Body.. pr ..... 89.99
- TGHCP-567 ..1955-57 Nomad Polished Stainless Steel Tailgate Hinge Covers ..... pr..... 169.99
- 20-387F .....1955-57 Sedan Delivery Tailgate Fasteners ..... set..... 20.99
- 20-387S .....1955-57 Wagon Upper & Lower Tailgate Fasteners kit..... 41.99
- 20-387S1 .....1955-57 Nomad Upper/Lower Tailgate Fasteners kit..... 41.99
- 20-385 .....1955-57 Station Wagon & Nomad Cargo, Tailgate and Rear Seat Area Trim Screws..... kit..... 41.99
- 20-413 .....1955-57 Nomad Tailgate Bar Clips..... set.... 104.99
- 20-477A.....1955-57 4-Dr Rear Hinge & Tailgate Hinge Screws set..... 16.99
- 20-477B.....1955-57 Wagon & Nomad Tailgate Hinge Screws set..... 11.99
- BTHN-567 ....1955-57 Nomad Billet Tailgate Hinges..... pr..... 299.99
- BTHW-567 ....1955-57 Wagon Billet Tailgate Hinges..... pr..... 299.99
- LGPSN-567 ..1955-57 Nomad Polished Stainless Liftgate Struts. pr..... 249.99
- LGPSW-567 ..1955-57 Wagon Polished Stainless Liftgate Struts.. pr..... 249.99
- TGG-567 .....1955-57 Station Wagon & Nomad Chrome Liftgate Alignment Guide on Tailgate ..... ea ..... 64.99
- TGBW-567 ...1955-57 Station Wagon & Nomad Chrome Tailgate Ball Retainers..... pr..... 54.99
- TGBC-567 ....1955-57 Station Wagon & Nomad Tailgate Cable Chrome Retainer Balls..... pr..... 54.99
- NTGS-567 ....1955-57 Nomad Tailgate Skin ..... ea ..... 329.99
- NWSCT-567 .1955-57 Station Wagon, Nomad & Sedan Delivery Chrome Tailgate Strikers..... pr..... 59.99

- NWST-567 ....1955-57 Station Wagon, Nomad & Sedan Delivery Polished Stainless Steel Tailgate Strikers.... pr..... 249.99
- NWCG-567..1955-57 Station Wagon & Nomad Polished Stainless Steel Tailgate Cable Guides ..... pr..... 269.99
- TG13-55 .....1955-57 Station Wagon Complete Tailgate ..... ea ..... 799.99
- TGS-567 .....1955-57 Station Wagon Tailgate Skin..... ea .... 199.99
- TGBR-567.....1955-57 Station Wagon & Nomad Tailgate Cable Retractor Brackets..... pr..... 54.99
- TGCS-567 ....1955-57 Nomad & Station Wagon Stainless Steel Inner Tailgate Latch Cover ..... ea ..... 99.99
- TGH-567 .....1955-57 Station Wagon Tailgate Hinges ..... pr..... 169.99
- TGLN-567 ....1955-57 Nomad Polished Stainless Steel Tailgate Latches with Rods, Clips & Hardware ..... pr..... 249.99
- TGLW-567 ....1955-57 Wagon/Sedan Delivery Polished Stainless Steel Tailgate Latches with Rods, Clips & Hardware ..... pr..... 249.99
- TGTSSD-567 1955-57 Sedan Delivery 5-Piece Custom Stainless Steel Inner Liftgate Trim..... set.... 329.99
- TGTSSW-567 1955-57 Station Wagon 6-Piece Stainless Steel Inner Tailgate Trim..... set.... 329.99
- TGTSW-567 ..1955-57 Station Wagon 6-Piece Inner Tailgate Painted Trim..... set.... 169.99
- WCDCS-567 1955-57 2&4-Door Station Wagon Rear Cargo Deck & Tailgate Stainless Trim ..... set.... 899.99
- WNCG-567..1955-57 Station Wagon & Nomad Tailgate Cable Body Guides ..... pr..... 49.99
- WTGH-567...1955-57 Wagon & Sedan Del Tailgate Handle ..... ea .... 259.99
- SSP-567 .....1955-57 Nomad/Station Wagon/Sedan Delivery Rear Body Polished Stainless Steel Sill Plate ..... ea .... 139.99
- LGGC-567 ...1955-57 Wagon Liftgate Glass Retainer Clips 4-Pc..... set..... 49.99
- 20-387D .....1955-57 Nomad Inner Window Frame Screw ..... kit..... 15.99
- CDLR-567.....1955-57 Station Wagon & Nomad Polished Stainless Steel Spare Tire Lid Lift Ring ..... ea ..... 59.99
- CDSC-567 ...1955-57 Nomad Rear Cargo Deck & Tailgate Stainless Trim ..... set.... 899.99
- CDSD-567 ...1955-57 Nomad Rear Cargo Deck Stainless Trim..... set.... 699.99
- CDST-567 .....1955-57 Nomad Tailgate Stainless Trim ..... set..... 229.99
- CTSB-567 .....1955-57 Nomad & Station Wagon Stainless Steel Seat Back Trim 12-Pc..... set.... 499.99



TPEL-57

LIFPW-57

LIFP-55

IFFP-56

RHFP-57

**TRI-FIVE  
FIN PANEL**

- TPEL-55 .....1955 Left Tailpan to Inner Fin Panel Patch ..... ea .... 139.99
- TPER-55 .....1955 Right Tailpan to Inner Fin Panel Patch..... ea .... 139.99
- LIFP-55 .....1955 Left Rear Inner Fin Panel..... ea ..... 249.99
- RIFP-55 .....1955 Right Rear Inner Fin Panel ..... ea ..... 249.99
- IFFP-56 .....1956 Non-Wagon Lower Inner Fin Panel Patch Panels ..... pr..... 249.99
- TPEL-57 .....1957 Left Tailpan to Inner Fin Panel Patch ..... ea ..... 94.99
- TPER-57 .....1957 Right Tailpan to Inner Fin Panel Patch..... ea ..... 94.99
- LIFP-57 .....1957 Left Rear Inner Fin Panel..... ea .... 239.99
- RIFP-57 .....1957 Right Rear Inner Fin Panel..... ea .... 239.99
- LIFPW-57 .....1957 Station Wagon & Delivery Left Inner Quarter Fin Panel..... ea ..... 309.99
- RIFPW-57 .....1957 Station Wagon & Delivery Right Inner Quarter Fin Panel..... ea ..... 309.99
- RHFP-57.....1957 Right Side Rear Fin Cover Plate..... ea ..... 49.99

**1955-57 CHEVY STATION WAGON & NOMAD CHROME LIFTGATE SUPPORTS**

*Original liftgate supports often need rebuilding and re-chroming before they can be installed on your Tri-5 Nomad or wagon. We've eliminated the need to fix your rusty or broken originals by offering beautiful show quality chrome plated reproductions. Exactly like the originals with partial and full open latches, releases and end brackets.*

- NLGS-567 ..... 1955-57 Nomad Chrome Liftgate Supports .....pr ... 169.99
- WLGS-567 .... 1955-57 Wagon Chrome Liftgate Supports .....pr ... 199.99



**TRI-FIVE EXTERIOR MOLDING**

PDVH-55	..... 1955 Bel Air Hardtop & Convertible Restored Upper Paint Dividers .....	pr	.... 399.99
PDVS-55	..... 1955 210/Bel Air 2&4-Door Sedan Restored Upper Paint Dividers .....	pr	.... 279.99
LHUDM-55	..... 1955 Bel Air Left Upper Stainless Steel Door Molding.....	ea	.... 54.99
RHUDM-55	..... 1955 Bel Air Right Upper Stainless Steel Door Molding.....	ea	.... 54.99
LHDM2SD-55	..... 1955 Bel Air 2-Door Sedan Left Lower Stainless Steel Door Molding.....	ea	.... 54.99
RHDM2SD-55	..... 1955 Bel Air 2-Door Sedan Right Lower Stainless Steel Door Molding.....	ea	.... 54.99
LHDM2HC-55	..... 1955 Bel Air 2-Door Hardtop & Convertible Left Lower Stainless Steel Door Molding.....	ea	.... 54.99
RHDM2HC-55	..... 1955 Bel Air 2-Door Hardtop & Convertible Right Lower Stainless Steel Door Molding .....	ea	.... 54.99
LHQPM2-55	.. 1955 Bel Air 2-Door Hardtop, Convertible & Sedan Left Lower Stainless Steel Door Molding.....	ea	.... 144.99
RHQPM2-55	.. 1955 Bel Air 2-Door Hardtop, Convertible & Sedan Right Lower Stainless Steel Door Molding.....	ea	.... 144.99
PDV-55	..... 1955 Lower Stainless Steel Paint Dividers.....	pr	.... 52.99
LHFM-55	... 1955 Bel Air Left Front Stainless Steel Fender Molding.....	ea	.... 64.99
RHFM-55	... 1955 Bel Air Right Front Stainless Steel Fender Molding .....	ea	.... 64.99
DPSC-567	..... 1955-57 Convertible Flat Pillar Post Stainless.....	pr	.... 89.99
CVTB-567	..... 1955-57 Convertible Stainless Steel Quarter Window Beltline Moldings.....	pr	.... 399.99
16515	..... 1955-57 2-Door Hardtop & Convertible Upper Door Beltline Stainless Moldings.....	pr	.... 109.99
DBSHC-567	... 1955-57 2-Door Hardtop & Convertible Restored Upper Door Beltline Stainless .....	pr	.... 279.99
BASSC-567	... 1955-57 Bel Air 4-Door Sedan Restored Post Beltline Stainless Connectors .....	set	.... 74.99
BLS210-567	.. 1955-57 210 2-Door Sedan Restored Beltline Stainless 4-Pc.....	set	.... 399.99
BLSBA2-567	.. 1955-57 Bel Air 2-Door Sedan Restored Beltline Stainless set - 12-Pieces.....	set	.. 1599.99
BLSBA4-567	.. 1955-57 Bel Air 4-Door Sedan Restored Beltline Stainless 14-Pc.....	set	.... 599.99
CPS-567	..... 1955-57 Bel Air 4-Door Sedan Lower Center Post Stainless .....	pr	.... 49.99
DTS210-567	.. 1955-57 210 2-Door Sedan & Station Wagon Door Beltline Stainless Trim .....	ea	.... 89.99
PDVHC-56	..... 1956 Bel Air 2-Door Hardtop & Convertible Restored Upper Paint Dividers .....	pr	.... 379.99
PDVS-56	..... 1956 Bel Air 2-Door Sedan Restored Upper Paint Dividers .....	pr	.... 379.99

BAS-56	..... 1955-56 Chrome Quarter Panel Bel Air Scripts .....	pr	.... 29.99
PDVS1-56	..... 1956 150 & 210 2&4-Door Sedan Restored Upper Paint Dividers .....	pr	.... 249.99
PDVS4-56	..... 1956 Bel Air 4-Door Sedan Restored Upper Paint Dividers .....	pr	.... 229.99
SMD4-56	..... 1956 Bel Air 4-Door Sedan & Station Wagon Center Post Divider Chrome Trim.....	set	.... 79.99
SMD4HT-56	... 1956 Bel Air 4-Door Hardtop Center Post Chrome Divider Trim.....	set	.... 79.99
FMLH-57	..... 1957 Left Vertical Fin Stainless Steel Molding Above Gas Door.....	ea	.... 99.99
FMRH-57	..... 1957 Right Vertical Fin Stainless Steel Molding .....	ea	.... 139.99
GDM-57	..... 1957 Stainless Steel Gas Door Assembly.....	ea	.... 109.99
57-FMS	..... 1957 Stainless Steel Fin Moldings (All 3).....	set	... 299.99
CM12-57	..... 1957 150 & 210 Series Quarter Panel Stainless Steel Crown Molding.....	ea	.... 69.99
CM12I-57	..... 1957 150 & 210 Series Stainless Steel Crown Molding Retainer with Pins .....	ea	.... 59.99
LCQP-57	..... 1957 210 & Bel Air 2-Door Left Upper Short Curved Quarter Stainless .....	ea	.... 39.99
RCQP-57	..... 1957 210 & Bel Air 2-Door Right Upper Short Curved Quarter Stainless .....	ea	.... 39.99
LDS-57	..... 1957 210 & Bel Air 2-Door Left Door Stainless.....	ea	.... 59.99
RDS-57	..... 1957 210 & Bel Air 2-Door Right Door Stainless .....	ea	.... 59.99
LFM-57	..... 1957 Left Front Fender Stainless.....	ea	.... 59.99
RFM-57	..... 1957 Right Front Fender Stainless .....	ea	.... 59.99
LLQP-57	..... 1957 210 & Bel Air 2-Door Left Long Lower Quarter Panel Stainless .....	ea	.... 79.99
RLQP-57	..... 1957 210 & Bel Air 2-Door Right Lower Quarter Stainless .....	ea	.... 79.99
LUQP-57	..... 1957 210 & Bel Air 2-Door Long Left Upper Quarter Stainless.....	ea	.... 49.99
RUQP-57	..... 1957 210 & Bel Air 2-Door Long Right Upper Quarter Stainless.....	ea	.... 49.99
PDVS-57	..... 1957 150 2&4-Door Sedan Restored Upper Stainless Paint Dividers.....	pr	.... 249.99
QPIB-57	..... 1957 Bel Air 2-Door Quarter Panel Aluminum Inserts without Scripts.....	pr	.... 679.99
QPI2-57	..... 1957 Bel Air 2-Door Aluminum Quarter Panel Inserts.....	pr	.... 679.99
QPI4H-57	..... 1957 Bel Air 4-Door Hardtop Aluminum Quarter Panel Inserts.....	pr	.... 679.99
QPI4S-57	..... 1957 Bel Air 4-Door Sedan & Station Wagon Aluminum Quarter Panel Inserts.....	pr	.... 679.99
SMD4-57	..... 1957 210 & Bel Air 4-Door Sedan & Station Wagon Center Post Chrome Divider Trim.....	pr	.... 59.99
SMD4HT-57	... 1957 210 & Bel Air 4-Door Hardtop Center Post Divider Chrome Trim.....	pr	.... 59.99
TCMB-57	..... 1957 Bel Air Except Wagon Stainless Steel Top Crown Molding with Insert (2 REQUIRED).....	ea	.... 199.99

**1957 CHEVY 2-DOOR COMPLETE SIDE STAINLESS SET**

Full kit includes all 10 pieces to complete both sides of your '57. The very best quality reproductions available - you'll be hard pressed to tell these from original GM parts. Fits all 2-door body styles, 210 or Bel Air hardtop, convertible, sedan, wagon & Nomad. Clip sets also available.



57STS	..... 1957 210 & Bel Air Complete Side Stainless Trim 10-Pc .....	set	.... 499.99
-------	---	-----	-------------

**TRI-FIVE WINDOW FLIPPERS**



FLPS-55	..... 1955 2-Door Hardtop Restored Stainless Steel Door Flippers.....	pr	.... 599.99
FLPS-67	..... 1956-57 2-Door Hardtop Restored Stainless Steel Door Flippers .....	pr	.... 599.99





20-281



20-370



20-377A

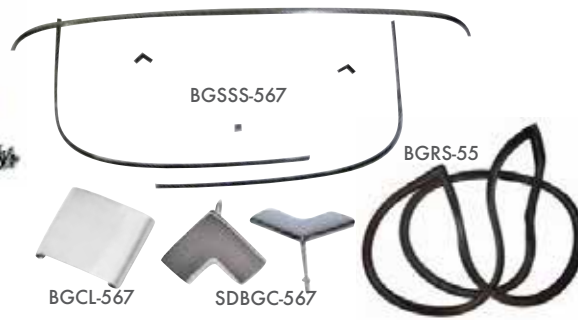

BGCL-567

SDBGC-567

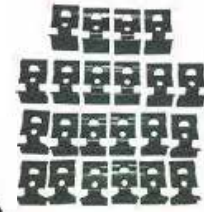

20-419

**TRI-FIVE EXTERIOR MOLDING CLIPS**

- 20-119..... 1955 Bel Air Complete Side Stainless Molding Clips..set ..... 74.99
- 20-148..... 1955 Rocker Molding Clips ..... set ..... 17.99
- 20-163..... 1955 210 Complete Side Stainless Molding Clips...set ..... 36.99
- 20-128..... 1956 Bel Air 2-Door Hardtop, Convertible & Sedan Complete Side Stainless Molding Clips..... set ..... 74.99
- 20-256..... 1956 Rocker Molding Clips ..... set ..... 20.99
- 20-165..... 1956 Bel Air 4-Door Sedan, Station Wagon & Hardtop Complete Side Stainless Molding Clips...set ..... 94.99
- 20-166..... 1956 210 2-Door Sedan,Wagon & Hardtop Complete Side Stainless Molding Clips..... set ..... 64.99
- 20-168..... 1956 150 2-Door Sedan & Wagon Complete Side Stainless Molding Clips..... set ..... 49.99
- 20-169..... 1956 210 4-Door Sedan,Wagon & Hardtop Complete Side Stainless Molding Clips..... set ..... 79.99
- 20-177..... 1956 150 4-Door Sedan & Wagon Complete Side Stainless Molding Clips ..... set ..... 59.99
- 20-007..... 1957 Vertical Fin Molding Retaining Clips ..... pr ..... 17.99
- 20-170A..... 1957 Bel Air & 210 4-Door Sedan, Hardtop & Station Wagon Complete Side Stainless Molding Clips..... set ..... 104.99
- 20-171..... 1957 150 2&4-Door Sedan & Station Wagon Complete Side Stainless Molding Clips..... set ..... 41.99
- 20-173..... 1957 Bel Air Crown Molding Clips (22) ..... set ..... 24.99
- 20-174..... 1957 150 & 210 Crown Molding Clips (6) ..... set ..... 12.99
- 20-370..... 1957 Bel Air Stainless Crown Molding Pin Retainers ..set .....54.99
- 20-370A..... 1957 Bel Air Station Wagon & Nomad Stainless Steel Crown Molding Pin Retainers..... set ..... 41.99
- 20-140A..... 1957 Bel Air & 210 2-Dr Hardtop, Convertible, Sedan, Wagon & Nomad Complete Side Stainless Molding Clips ... set ..... 84.99
- 20-370B..... 1957 150 & 210 Stainless Steel Crown Molding Pin Retainers ..... set ..... 20.99
- 20-557..... 1957 Stainless Steel Gas Door Area Hardware ..... set ..... 14.99

- 20-557A..... 1957 Stainless Steel Rear Fin Area Hardware ..... set ..... 7.99
- 20-175..... 1957 V8 Trunk V Clips..... set ..... 5.99
- 20-178R..... 1955-57 210 2-Door Station Wagon Beltline Stainless Steel Molding Clips..... set ..... 69.99
- 20-123R..... 1955-57 210 2-Door Sedan Beltline Stainless Steel Molding Clips..... set ..... 51.99
- 20-164R..... 1955-57 210 4-Door Sedan Beltline Stainless Steel Molding Clips..... set ..... 64.99
- 20-179R..... 1955-57 210 & Bel Air 4-Door Station Wagon Beltline Stainless Steel Molding Clips ..... set ..... 84.99
- 20-187SS ... 1955-57 2-Door Hardtop/Convertible/Nomad Door Beltline Stainless Screws ..... set ..... 8.99
- 20-376A..... 1955-57 Bel Air 4-Door Sedan Upper & Lower Stainless Steel Beltline Molding Clips ..... set ... 169.99
- 20-377A..... 1955-57 Bel Air 2-Door Sedan Upper & Lower Stainless Steel Beltline Molding Clips ..... set ... 129.99
- 20-388C ... 1955-57 210 2-Door Wagon Complete Upper & Lower Roofline/Beltline Clips..... set ...209.99
- 20-388D ... 1955-57 210 & Bel Air 4-Door Wagon Complete Upper & Lower Roofline/Beltline Clips..... set ...259.99

**TRI-FIVE CHEVY WINDSHIELD SUNVISORS**



- HTV-567 ... 1955-57 2-Door Hardtop & Nomad Outside Sunvisor Complete..... ea ... 549.99
- SDV-567 ... 1955-57 2 and 4-Door Sedan, Station Wagon Outside Sunvisor Complete..... ea ... 549.99

**TRI-FIVE BACK GLASS**



BGHT-567

- BGRS-55 ..... 1955 2/4-Dr Sedan Back Glass Rubber (Exc150)..... ea ..... 54.99
- IBGT-55 ..... 1955 Used Inner Backglass Trim 3-Pc..... set... 269.99
- 20-419 ..... 1955-57 Rear Glass Molding Clips 22-Pc ..... set..... 12.99
- BGHC-567 ..... 1955-57 2-Door Hardtop Clear Back Glass..... ea ... 299.99
- BGHS-567 ..... 1955-57 2-Dr Hardtop Gray Smoke Back Glass..... ea... 329.99
- BGHT-567 ..... 1955-57 2-Door Hardtop Tinted Back Glass .... ea... 299.99
- BGLLH-567 ..... 1955-57 Restored 2-Door Hardtop Backglass Left Lower Stainless Steel Molding..... ea... 179.99
- BGRLLH-567 ..... 1955-57 Restored 2-Door Hardtop Backglass Right Lower Stainless Steel Molding ..... ea ... 179.99
- BGLLS-567 ..... 1955-57 Restored 2&4-Door Sedan Backglass Left Lower Stainless Steel Molding..... ea ... 159.99
- BGRLLS-567 ..... 1955-57 Restored 2&4-Door Sedan Backglass Right Lower Stainless Steel Molding ..... ea ... 159.99
- BGRHT-67 ..... 1956-57 4-Door Hardtop Back Glass Rubber .. ea ..... 59.99
- BGRS-67 ..... 1956-57 2&4-Door Sedan Back Glass Rubber . ea ..... 39.99
- BGS4H-67 ..... 1956-57 4-Door Hardtop Restored Back Glass Stainless 4-Pc ..... set... 499.99
- BGSC-567 ..... 1955-57 2&4-Door Sedan Clear Back Glass.... ea ... 299.99



IBGT-55

- BGSH-567 ..... 1955-57 2-Door Hardtop Restored Back Glass Stainless 6-Pc ..... set... 529.99
- BGSS-567 ..... 1955-57 2&4-Door Sedan Smoke Gray Back Glass ..... ea ... 329.99
- BGST-567 ..... 1955-57 2&4-Dr Sedan Tinted Back Glass..... ea ... 299.99
- BGSSS-567 ..... 1955-57 2&4-Door Sedan Restored Back Glass Stainless 6-Pc ..... set... 479.99
- BGUS-567 ..... 1955-57 Restored 2&4-Door Sedan Back Glass Upper Stainless Steel Molding..... ea ... 259.99
- SS-1202 ..... 1955-57 2-Door Hardtop Back Glass Rubber .. ea ..... 39.99
- SDBGC-567 ..... 1955-57 2&4-Door Sedan Back Glass Stainless Upper Corner Connectors with Studs.. pr ..... 22.99
- HTBGC-567 ..... 1955-57 2-Door Hardtop Back Glass Stainless Upper Corner Connectors with Studs.. pr ..... 22.99
- BGCL-567 ..... 1955-57 Lower Center Back Glass Stainless Steel Molding Connector ..... ea ..... 14.99
- BGL4-67 ..... 1956-57 4-Door Hardtop Lower Center Back Glass Stainless Steel Molding Connector ..... ea ..... 14.99
- BG4HTC-67 ..... 1956-57 4-Door Hardtop Sport Sedan Clear Back Glass ..... ea ... 239.99
- BG4HTT-67 ..... 1956-57 4-Door Hardtop Sport Sedan Green Tint Back Glass..... ea ... 239.99
- BG4HTS-67 ..... 1956-57 4-Door Hardtop Sport Sedan Smoke Grey Back Glass..... ea ... 239.99



**TRI-FIVE WINDSHIELD**

WSDS-55.....	1955 Windshield Drain Seals and Tubes.....	pr	15.99
CDS001 .....	1955-57 Convertible Upper Inner Windshield Stainless Molding Behind Mirror Bracket .....	ea	32.99
20-172 .....	1955-57 Lower Windshield Molding Clips .....	set	16.99
20-188SS .....	1955-57 Stainless Steel Windshield Pillar Screw.....	set	9.99
20-205 .....	1955-57 Lower Outer Corner Windshield Molding Clips .....	pr	14.99
20-396 .....	1955-57 Conv. Windshield Frame Hardware .....	set	12.99
CVWF-1 .....	1955-57 Convertible Windshield Frame.....	ea	499.99
CWH-567 .....	1955-57 Convertible Front Upper Windshield Header on Body.....	ea	129.99
FGF-567 .....	1955-57 Front Windshield Lower Gasket Channels (Weld-on) .....	pr	89.99
GMLUH-567...	1955-57 Used 2&4-Door Hardtop & Nomad Used Left Upper Inner Windshield Garnish Molding .....	ea	49.99
GMRUH-567 ..	1955-57 Used 2&4-Door Hardtop & Nomad Used Right Upper Inner Windshield Garnish Molding .....	ea	49.99
GMLUS-567 ...	1955-57 Used 2&4-Door Sedan & Station Wagon Used Left Upper Inner Windshield Garnish Molding .....	ea	39.99
GMRUS-567 ...	1955-57 Used 2&4-Door Sedan & Station Wagon Used Right Upper Inner Windshield Garnish Molding .....	ea	39.99
LLWC-567 .....	1955-57 Left Lower Windshield Stainless Steel Corner Molding .....	ea	54.99
RLWC-567 .....	1955-57 Right Lower Windshield Stainless Steel Corner Molding .....	ea	54.99
SS-1201 .....	1955-57 Windshield Rubber .....	ea	49.99
SS-1231 .....	1955-57 2-Door Hardtop & Convertible Vertical Windshield Pillar Seals.....	pr	9.99
WSCL-567 .....	1955-57 Lower Center Windshield Stainless Steel Molding Connector .....	ea	14.99

WSCU-567 .....	1955-57 Upper Center Windshield Stainless Steel Molding Connector .....	ea	14.99
WSSU-567 .....	1955-57 2&4-Door Sedan & Station Wagon Restored Stainless Steel Upper Windshield Trim.....	set	299.99
WSHU-567 .....	1955-57 2-Door Hardtop, Nomad & 1956-57 4-Dr Hardtop Restored Stainless Steel Upper Windshield Trim.....	set	359.99
CWSU-567 .....	1955-57 Convertible Upper Outer Center Windshield Stainless Molding .....	ea	139.99
WSHC-56 .....	1955-56 2-Door Hardtop & Convertible Clear Windshield .....	ea	249.99
WSHG-56.....	1955-56 2-Door Hardtop & Convertible Smoke Gray Windshield.....	ea	259.99
WSHT-56 .....	1955-56 2-Door HT & Conv. Tinted Windshield .....	ea	249.99
WSSC-56.....	1955-56 2-Door Sedan & Station Wagon Clear Windshield .....	ea	249.99
WSSG-56 .....	1955-56 2-Door Sedan & Station Wagon Smoke Gray Windshield.....	ea	259.99
WSST-56.....	1955-56 2-Door Sedan & Station Wagon Tinted Windshield .....	ea	249.99
WSSS-56 .....	1955-56 2&4-Door Sedan/Station Wagon Restored Windshield Stainless 8-Pc .....	set	499.99
WSTL-56.....	1955-56 Lower Outer Windshield Stainless 3-Pc.....	set	179.99
WSTLL-56 .....	1955-56 Left Lower Outer Windshield Stainless .....	ea	84.99
WSTRL-56 .....	1955-56 Right Lower Outer Windshield Stainless .....	ea	84.99
WSSH-56.....	1955-56 2-Door Hardtop Restored Windshield Stainless 8-Pc.....	set	529.99
WSDS-67.....	1956-57 Windshield Drain Seals & Tubes.....	pr	15.99
WSHC-57 .....	1957 2-Door Hardtop & Convertible Clear Windshield .....	ea	249.99
WSHG-57.....	1957 2-Door Hardtop & Convertible Smoke Gray Windshield.....	ea	259.99
WSHT-57 .....	1957 2-Door Hardtop & Convertible Tinted Windshield .....	ea	249.99
WSSC-57 .....	1957 2-Door Sedan & Station Wagon Clear Windshield .....	ea	249.99
WSSG-57 .....	1957 2-Door Sedan & Station Wagon Smoke Gray Windshield.....	ea	259.99
WSST-57 .....	1957 2-Door Sedan & Station Wagon Tinted Windshield .....	ea	249.99
WSSH-57 .....	1957 2-Door Hardtop Restored Windshield Stainless 8-Pc.....	set	529.99
WSSS-57 .....	1957 2&4-Door Sedan/Station Wagon Restored Windshield Stainless 8-Pc .....	set	499.99
WSTL-57 .....	1957 Outer Lower Windshield Stainless 3-Pc.....	set	179.99
WSTLL-57 .....	1957 Left Lower Outer Windshield Stainless .....	ea	84.99
WSTRL-57 .....	1957 Right Lower Outer Windshield Stainless .....	ea	84.99
VWSMHL-567...	1955-57 Used 2&4-Door Hardtop & Nomad Used Left Vertical Inside Windshield Garnish Molding .....	ea	99.99
VWSMHR-567...	1955-57 Used 2&4-Door Hardtop & Nomad Used Right Vertical Inside Windshield Garnish Molding .....	ea	99.99
VWSMSL-567....	1955-57 Used 2&4-Dr Sedan & Station Wagon Except Nomad Used Left Vertical Inside Windshield Garnish Molding .....	ea	49.99
VWSMSR-567 ...	1955-57 Used 2&4-Dr Sedan & Station Wagon Except Nomad Used Right Vertical Inside Windshield Garnish Molding .....	ea	49.99
SLUWSM-567 ...	1955-57 Left Upper Sedan/Wagon Windshield Stainless Molding .....	ea	94.99
SRUWSM-567 ...	1955-57 Right Upper Sedan/Wagon Windshield Stainless Molding.....	ea	94.99



**TRI-FIVE WINDOW FELT KITS**

18-184A.....	1956-57 4-Dr Hardtop Window Felt Whisker Channels kit...	139.99
18-219 .....	1955-57 Nomad Window Felt Whisker Channels.....	169.99
18-346.....	1955-56 Bel Air 2-Door Hardtop Window Felt Whisker Channels .....	139.99
18-347 .....	1955-56 Bel Air Convertible Window Felt Whisker Channels .....	139.99
18-348.....	1957 Bel Air 2-Door Hardtop Window Felt Whisker Channels .....	139.99
18-349 .....	1957 Bel Air Convertible Window Felt Whisker Channels .....	149.99
18-370A.....	1955-57 2-Door Sedan Side Glass Fuzzy Channels.kit...	289.99
18-370B.....	1955-57 4-Door Sedan Side Glass Fuzzy Channels.kit...	289.99
18-370C .....	1955-57 2-Door Station Wagon Side Glass Fuzzy Channels .....	289.99
18-370D .....	1955-57 4-Door Station Wagon Side Glass Fuzzy Channels .....	289.99
18-370E.....	1955-57 2-Door Sedan & Station Wagon Front Door Glass Only Glass Fuzzy Channels .....	189.99
RDWC4-567 ...	1955-57 4-Door Sedan Rear Door Window Glass Channels .....	189.99

**TRI-FIVE VENT WINDOW**



VSSCV-55 ..... 1955 Convertible 8-Pc Vent Window Area Restored Stainless Steel .....set .. 449.99	SS-1032 ..... 1955-57 2&4-Door Hardtop, Convertible & Nomad Vent Window Weatherstripping.....set .... 69.99
15514 ..... 1955-57 2-Door Hardtop & 1955 Convertible Vent Window Stainless Cap Molding "Short" .....ea .... 24.99	SS-1033 ..... 1955-57 2&4-Door Sedan, Wagon (exc Nomad) & Sedan Delivery Vent Window Weatherstripping.....set .... 69.99
16953 ..... 1956-57 Convertible Vent Window Stainless Cap Moldings "Long" .....pr ..... 79.99	SVWAL-567 ..... 1955-57 Sedan & Station Wagon Left Vent Window Assembly, Clear Glass.....ea .. 339.99
CH13-55 ..... 1955-57 Vent Window Crank Handle w/Knob ...ea .... 14.99	SVWAR-567 ..... 1955-57 Chevy Sedan & Station Wagon Left Vent Window Assembly, Clear Glass.....ea .. 339.99
SVWL-567 ..... 1955-57 Sedan/Station Wagon/Delivery Chrome Left Vent Frame with Latch .....ea .... 89.99	SVWAPU-567.... 1955-57 2&4-Door Sedan, Station Wagon & Sedan Delivery Used Vent Window Assemblies.....pr ... 169.99
SVWR-567 ..... 1955-57 Sedan/Station Wagon/Delivery Chrome Right Vent Frame with Latch .....ea .... 89.99	SVWL-567 ..... 1955-57 Sedan/Station Wagon/Delivery Chrome Left Vent Frame with Latch .....ea .... 89.99
20-401 ..... 1955-57 2&4-Door Hardtop, Convertible & Nomad Vent Window Assembly Screw .....set .... 19.99	SVWR-567 ..... 1955-57 Sedan/Station Wagon/Delivery Chrome Right Vent Frame with Latch .....ea .... 89.99
20-402 ..... 1955-57 2&4-Door Sedan, Station Wagon & Sedan Delivery Vent Window Assembly Screw .....set ..... 7.99	SVWP-567..... 1955-57 Sedan/Station Wagon/Delivery Chrome Vent Window Frames with Latches.....pr ... 169.99
CVFL-567 ..... 1955-57 Conv Chrome Left Vent Window Frame ..ea .... 89.99	VSSHT-567 ..... 1955-57 2-Door Hardtop 8-Pc Vent Window Area Restored Stainless Steel .....set .. 449.99
CVFR-567 ..... 1955-57 Conv Chrome Right Vent Window Frame...ea .... 89.99	VWS-567 ..... 1955-57 2&4-Door Hardtop and Convertible Upper Vent Window Stops.....pr ..... 15.99
HTVWAL-567 .... 1955-57 2-Door Hardtop Left Vent Window Assembly, Clear Glass .....ea .. 339.99	VWSLH-567 ..... 1955-57 Hardtop/Convertible Nomad Left Vertical Vent Window Channel Stainless Trim .....set .... 44.99
HTVWAR-567.... 1955-57 2-Door Hardtop Right Vent Window Assembly, Clear Glass .....ea .. 339.99	VWSRH-567..... 1955-57 Hardtop/Convertible Nomad Right Vertical Vent Window Channel Stainless Trim .....set .... 44.99
HVWAL-567..... 1955-57 Convertible Left Vent Window Assembly, Clear Glass .....ea .. 339.99	VWSLS-567 ..... 1955-57 2&4-Door Sedan and Station Wagon Left Vertical Vent Window Channel Stainless Trim .....set .... 44.99
HVWAR-567 .... 1955-57 Convertible Right Vent Window Assembly, Clear Glass .....ea .. 339.99	VWSRS-567 ..... 1955-57 2&4-Door Sedan and Station Wagon Right Vertical Vent Window Channel Stainless Trim .....set .... 44.99
HVWAPU-567... 1955-57 2&4-Door Hardtop, Convertible Used Vent Window Assemblies.....pr ... 289.99	VWASS-567 ..... 1955-57 2&4-Door Sedan & Station Wagon Lower Vent Window Assembly Adjusting Stud (2 req.).....ea ..... 9.99
HVWL-567 ..... 1955-57 Hardtop & Nomad Left Chrome Vent Window Frame with Latch.....ea .... 89.99	VSSN-567 ..... 1955-57 Nomad Vent Window Area Restored Stainless Steel 6-Pc.....set .. 359.99
HVWR-567 ..... 1955-57 Hardtop & Nomad Right Chrome Vent Window Frame with Latch.....ea .... 89.99	VSS4HT-67 ..... 1956-57 4-Door Hardtop Vent Window Area Restored Stainless Steel 8-Pc.....set .. 399.99
NVWAL-567 ..... 1955-57 Nomad Left Vent Window Assembly, Clear Glass .....ea .. 359.99	VSSCV-67 ..... 1956-57 Convertible 8-Pc Vent Window Area Restored Stainless Steel .....set .. 449.99
NVWAR-567 ..... 1955-57 Nomad Right Vent Window Assembly, Clear Glass .....ea .. 359.99	
VWRL-567 ..... 1955-57 Left Vent Window Regulator .....ea .... 99.99	
VWRR-567 ..... 1955-57 Right Vent Window Regulator.....ea .... 99.99	



**TRI-FIVE SIDE GLASS**

20-263A..... 1955-57 Nomad Side Glass Stainless Steel Molding Screws .....set ..... 13.99	SSGT-567 ..... 1955-57 2-Door Sedan 6-Pc Side Glass Installed with Tinted Glass.....set ... 554.99
20-298 ..... 1955-57 2-Door Hardtop/Convertible/Nomad Side Glass Chrome Frame Screws.....set ..... 9.99	4DGSAC-567 ... 1955-57 4-Door Sedan 8-Pc Side Glass Installed with Clear Glass .....set .... 459.99
20-464AS..... 1955-57 Nomad Slider Glass Channel Clips .....set ..... 22.99	4DGSAT-567 .... 1955-57 4-Door Sedan 8-Pc Side Glass Installed with Green Tint Glass.....set ... 459.99
HSGC-567 ..... 1955-57 2-Door Hardtop 6-Pc Side Glass Chrome Frames Installed with Clear Glass.....set . 1049.99	4DGSAS-567.... 1955-57 4-Door Sedan 8-Pc Side Glass Installed with Gray Smoke Glass.....set ... 459.99
HSGS-567 ..... 1955-57 2-Door Hardtop 6-Pc Side Glass Chrome Frames Installed w/Smoke Gray Glass set . 1049.99	CSGC-567 ..... 1955-57 Convertible 6-Pc Side Glass Chrome Frames Installed with Clear Glass.....set . 1049.99
HSGT-567 ..... 1955-57 2-Door Hardtop 6-Pc Side Glass Chrome Frames Installed with Tinted Glass.....set . 1049.99	CSGS-567 ..... 1955-57 Convertible 6-Pc Side Glass Chrome Frames Installed w/Gray Smoke Glass set . 1049.99
SSGC-567 ..... 1955-57 2-Door Sedan 6-Pc Side Glass Installed with Clear Glass .....set ... 554.99	CSGT-567 ..... 1955-57 Convertible 6-Pc Side Glass Chrome Frames Installed with Tinted Glass.....set . 1049.99
SSGS-567 ..... 1955-57 2-Door Sedan 6-Pc Side Glass Installed with Smoke Gray Glass.....set ... 554.99	CQWGL-567.... 1955-57 Convertible Chrome Left Quarter Window Frame Assembly With Clear Glass .....ea .... 399.99
	CQWGR-567 ... 1955-57 Convertible Chrome Right Quarter Window Frame Assembly With Clear Glass .....ea .... 399.99



**TRI-FIVE DOOR WINDOW**

- CH13-551..... 1955-57 Window Crank Handle with Knob .....ea..... 14.99
- 18-133..... 1955-57 2-Door Hardtop & Convertible Left  
Horizontal Door Glass Setting Channel .....ea..... 36.99
- 18-134..... 1955-57 2-Door Hardtop & Convertible Right  
Horizontal Door Glass Setting Channel .....ea..... 36.99
- 18-135..... 55-57 Nomad Lt Horiz Door Glass Setting Channel .ea..... 36.99
- 18-136..... 55-57 Nomad Rt Horiz Door Glass Setting Channel .ea..... 36.99
- 18-137..... 1955-57 2-Door Sedan, Station Wagon & Sedan Delivery  
Left Horizontal Door Glass Setting Channel .....ea..... 34.99
- 18-138..... 1955-57 2-Door Sedan, Station Wagon & Sedan Delivery  
Right Horizontal Door Glass Setting Channel.....ea..... 34.99
- 18-138T..... 1955-57 2-Door Lower Door Glass  
Regulator Roller Channel .....ea..... 34.99
- 18-141..... 1955-57 4-Door Sedan & Station Wagon Left  
Horizontal Front Door Glass Setting Channel .....ea..... 28.99
- 18-142..... 1955-57 4-Door Sedan & Station Wagon Right  
Horizontal Front Door Glass Setting Channel .....ea..... 28.99
- 18-141T..... 1955-57 4-Door Sedan & Station Wagon Lower  
Front Door Glass Regulator Roller Channel .....ea..... 24.99
- 18-143..... 1955-57 4-Door Sedan & Station Wagon Left  
Horizontal Rear Door Glass Setting Channel .....ea..... 28.99
- 18-144..... 1955-57 4-Door Sedan & Station Wagon Right  
Horizontal Rear Door Glass Setting Channel .....ea..... 28.99
- 18-143T..... 1955-57 4-Door Sedan & Station Wagon Lower  
Rear Door Glass Regulator Roller Channel .....ea..... 28.99
- 18-151L..... 1955-57 2-Door Hardtop & Convertible Left  
Vertical Door Glass Rear Channel .....ea..... 41.99



- 18-151R..... 1955-57 2-Door Hardtop & Convertible Right  
Vertical Door Glass Rear Channel .....ea..... 41.99
- DGRR-567..... 1955-57 2-Door Hardtop, Nomad &  
Convertible Door Glass Inner Roller .....ea..... 12.99
- 20-394..... 1955-57 Window Regulator Screws (8) .....set ..... 8.99
- DGS-567..... 1955-57 Upper Door Glass Adjusting Assemblies.pr ..... 24.99
- DIT-567..... 1955-57 Used Door Window Regulator Idler Track...ea..... 24.99
- DWRHL-567 .... 1955-57 2-Door Hardtop/Convertible Left Door  
Window Regulator.....ea... 129.99
- DWRHR-567 .... 1955-57 2-Door Hardtop/Convertible Right Door  
Window Regulator.....ea... 129.99
- DWRSL-567 .... 1955-57 2-Door Sedan/Wagon Left Door  
Window Regulator.....ea... 129.99
- DWRSR-567 .... 1955-57 2-Door Sedan/Wagon Right Door  
Window Regulator.....ea... 129.99
- 18-159A..... 1955-57 2-Door Sedan & Station Wagon Door  
Vertical Steel Rear of Door Run Channel.....ea..... 15.99
- DWADJ-567 .... 1955-57 2-Door Hardtop, Convertible & Nomad Door Glass  
Channel Adjusting Plates & Hardware .....kit ..... 13.99
- LHDT4-67 ..... 1956-57 4-Door Hardtop Used Left Vertical  
Front Door Vertical Glass Rear Channel.....ea..... 64.99
- RHDT4-67 ..... 1956-57 4-Door Hardtop Used Right Vertical  
Front Door Vertical Glass Rear Channel.....ea..... 64.99
- DWR4HTL-67 .. 1956-57 4-Dr Hardtop LF Door Window Regulator..ea... 134.99
- DWR4HTR-67 .. 1956-57 4-Dr Hardtop RF Door Window Regulator..ea... 134.99



**TRI-FIVE TAILLIGHT**

- 12-244.....1955 Chrome Taillight Bezel (2 Required) .....ea.....30.99
- 20-147.....1955 Taillight Housing & Bezel Installation w/Seals.....kit .....16.99
- 20-155.....1955 Chrome Taillight Bezel Screws .....set .....1.99
- SS-1112.....1955 Parking Light & Taillight Lens Gaskets .....set .....10.99
- TLAS-55 .....1955 Complete Taillight Assemblies .....pr ... 269.99
- TLH-55.....1955 Taillight Housing.....ea.....49.99
- TLS-55.....1955 Stainless Steel Taillight Lens Retainer/Dividers .....pr .....17.99
- TLV-55.....1955 Chrome V8 Under Taillight Emblems.....pr .....49.99
- TPA1020 ....1955 Taillight Lens (2 Required) .....ea.....9.99
- TPA1021 ....1955 Inner Taillight Lens Refractor (2 Required).....ea.....6.99
- SS-1113.....1956 Parking Light, Taillight & Backup Lens Gaskets...set .....10.99
- TLHP-56.....1956 Chrome Taillight Housing Assemblies Complete.pr ... 459.99
- TLV-56 .....1956 Nomad Chrome V8 Under Taillight Emblems.....pr .....74.99
- TP1315 .....1956 Taillight Small Reflector Assembly (2 Required).....ea.....29.99
- TPA1380 ....1956 Taillight Lens (2 Required) .....ea.....9.99
- 20-471.....1957 Taillight Housing Stud Mounting .....kit .....9.99
- TLDS-57 .....1957 Taillight to Bumper Dust Seals with Retainers.....pr .....27.99
- TLHP-57.....1957 Chrome Taillight Housing Assemblies Complete.pr ... 339.99
- TPA1480 ....1957 Taillight Lenses .....pr .....12.99
- FRLGS-57...1957 Parking Light, Taillight & Backup Lens Gaskets...set .....10.99

**TRI-FIVE BACKUP LIGHT**

- TPA1022... 1955 Backup Light Lens (2 Rqd) .ea ...12.99
- TPA1381... 1956 Backup Light Lens (2 Rqd) .ea .....9.99
- BUL-57 .... 1957 Backup Light Assemblies.....pr .144.99



**TRI-FIVE HEADLIGHT**

- HLB-55..... 1955 Headlight Bucket, Sub-Bucket & Ring Assembly .ea .... 89.99
- 20-412A...1955 Headlight Bezel & Bucket Screws .....set ..... 6.99
- FFIHL-55...1955 Left/Right Inner Headlight Cap Repair Panel .....ea .... 57.99
- HLBZ-55 ...1955 Chrome Headlight Bezels.....pr ..... 94.99
- HLRS-55 ...1955 Stainless Steel Headlight Retainer Ring .....ea .... 29.99
- 20-412.....1955-57 Headlight Adjuster & Bucket Mounting .....kit ..... 15.99
- 20-412D ..1955-57 Headlight Adjuster & Screws .....kit ..... 12.99
- HBS-567...1955-57 Headlight Bucket to Fender Seals.....pr ..... 10.99
- 17-231.....1956 Headlight Bucket.....ea .... 47.99
- 20-412B...1956 Headlight Bezel & Bucket Screws .....set ..... 6.99
- HLB-56.....1956 Chrome Headlight Bezels.....pr ..... 94.99
- HLRS-67 ....1956-57 Stainless Steel Headlight Retainer Ring .....ea .... 24.99
- HLB-57 .....1957 Headlight Bucket, Sub-Bucket & Ring Assembly .ea .... 89.99
- 20-412C ..1957 Headlight Bezel & Bucket Screws .....set ..... 8.99
- HLBZ-57 ...1957 Chrome Headlight Bezels.....pr ... 199.99
- DNT-567 ..55-57 Wiper Switch Nut & 57 Headlight Switch Nut Tool ....ea .... 18.99
- DMSP-57 ..1957 Dimmer Switch Floor Plate .....ea .... 41.99

**TRI-FIVE PARKING LIGHT**

- PLH-55.....1955 Chrome Parking Light Housings...pr..... 149.99
- SS-1112 .... 1955 Parking Light & Taillight Lens Gaskets.....set .... 10.99
- TPA1025.... 1955 Parking Light Lenses .....pr ..... 18.99
- PLH-56 ..... 1956 Chrome Parking Light Housings.....pr ...144.99
- PLHB-56 .... 1956 Chrome Parking Light Backing Panels .....pr ...169.99
- SS-1113 .... 1956 Parking Light, Taillight & Backup Lens Gaskets...set .... 10.99
- TPA1385.... 1956 Parking Light Lens (2 Required) .....ea ..... 12.99
- TP1401A.... 1957 Grillebar Parking Light Housings.....pr .....28.99
- TPA1481 .... 1957 Parking Light Lenses .....pr ..... 13.99
- FRLGS-57 ..1957 Parking Light, Taillight & Backup Lens Gaskets..set .... 10.99



**TRI-FIVE QUARTER WINDOW**

- 18-139 ..... 1955-57 2-Door Sedan Left Horizontal Rear Quarter Glass Setting Channel..... ea ..... 41.99
- 18-140 ..... 1955-57 2-Door Sedan Right Horizontal Rear Quarter Glass Setting Channel..... ea ..... 41.99
- 18-139A ..... 1955-57 2-Door Station Wagon Left Horizontal Rear Quarter Glass Setting Channel..... ea ..... 36.99
- 18-140A ..... 1955-57 2-Door Station Wagon Right Horizontal Rear Quarter Glass Setting Channel . ea ..... 36.99
- 18-139T ..... 1955-57 2-Door Lower Quarter Glass Regulator Roller Channel ..... ea ..... 24.99
- 20-187A ..... 1955-57 2-Door Hardtop or Convertible Quarter Window Stainless Steel Beltline Trim Screws ..... set ..... 4.99
- 20-187B ..... 1955-57 2-Door Hardtop Door Flipper & Upper Quarter Channel Stainless Steel Trim Screws..... set ..... 8.99
- 20-405C ..... 1955-57 Convertible Quarter Window Channel Hardware ..... set ..... 11.99
- 20-464BS ..... 1955-57 Station Wagon & Nomad Curved Quarter Glass Upper Clips..... set ..... 30.99
- 20-464CS ..... 1955-57 Station Wagon & Nomad Quarter Window Fixed Glass Lower Retainer Clips..... set ..... 41.99
- CQWP-567 ..... 1955-57 Convertible Quarter Window Pivot Assemblies..... pr ..... 279.99
- CVTB-567 ..... 1955-57 Convertible Stainless Steel Quarter Window Beltline Moldings ..... pr ... 399.99
- HQWTLL-567 ... 1955-57 2-Door Hardtop Left Long Quarter Window Track ..... ea ..... 59.99
- HQWTLR-567 ... 1955-57 2-Door Hardtop Right Long Quarter Window Track ..... ea ..... 59.99
- HQWTSL-567 ... 1955-57 2-Door Hardtop Left Curved Small Quarter Window Track ..... ea ..... 49.99
- HQWTSR-567 ... 1955-57 2-Door Hardtop Right Curved Small Quarter Window Track ..... ea ..... 49.99
- QWSC-567 ..... 1955-57 Convertible Quarter Window U-Jamb Seal Stops..... pr ..... 14.99

- QWSH-567 ..... 1955-57 2-Door Hardtop Quarter Window U-Jamb Seals ..... pr ..... 19.99
- QGSC-567 ..... 1955-57 Conv Quarter Window Rear Body Seals .. pr ..... 32.99
- QBH-567 ..... 1955-57 Bel Air 2-Door Hardtop Restored Quarter Window Beltline Stainless ..... pr ... 289.99
- QCHT-567 ..... 1955-57 2-Door Hardtop Restored Rear Upper Quarter Channels ..... pr ... 399.99
- QWFHT-567 ..... 1955-57 2-Door Hardtop Chrome Quarter Window Frames..... pr ... 389.99
- QWLR-567 ..... 1955-57 2-Door Hardtop & Convertible Upper Quarter Windlace Brackets..... pr ..... 29.99
- QWRCL-567 ..... 1955-57 Convertible Left Rear Quarter Window Regulator ..... ea ... 129.99
- QWRCR-567 ..... 1955-57 Convertible Right Rear Quarter Window Regulator ..... ea ... 129.99
- QWRHL-567 ..... 1955-57 2-Door Hardtop Left Quarter Window Regulator ..... ea ... 119.99
- QWRHR-567 ..... 1955-57 2-Door Hardtop Right Quarter Window Regulator ..... ea ... 119.99
- QWRSL-567 ..... 1955-57 2-Door Sedan Left Rear Quarter Window Regulator ..... ea ... 129.99
- QWRSR-567 ..... 1955-57 2-Door Sedan Right Rear Quarter Window Regulator ..... ea ... 129.99
- QWTL-567 ..... 1955-57 Convertible Left Lower Rear Quarter Glass Track with Liner ..... ea ... 139.99
- QWTR-567 ..... 1955-57 Convertible Right Lower Rear Quarter Glass Track with Liner ..... ea ... 139.99
- SQWC-567 ..... 1955-57 2-Door Sedan Quarter Window Channel Forward Guides..... pr ..... 27.99
- SQWTLL-567 .... 1955-57 2-Dr Sedan Left Long Quarter Window Track..... ea ..... 59.99
- SQWTLR-567 ... 1955-57 2-Dr Sedan Right Long Quarter Window Track ..... ea ..... 59.99
- SQWTSL-567 .... 1955-57 2-Door Sedan Left Curved Small Quarter Window Track ..... ea ..... 49.99
- SQWTSR-567 .... 1955-57 2-Door Sedan Right Curved Small Quarter Window Track ..... ea ..... 49.99
- SS-1212A ..... 1955-57 2-Door Hardtop & Convertible Vertical Quarter Window Rubber Seals ..... pr ..... 9.99



**TRI-FIVE LICENSE PLATE**

- 20-277 ..... 1957 Rear License Plate Mounting ..... kit ..... 9.99
- 20-442 ..... 1957 License Plate Light Mounting Hardware ..... kit ..... 3.99
- LPBF-55 ..... 1955 Front License Plate Bracket ..... ea ..... 17.99
- LPBF-56 ..... 1956 Front License Plate Bracket ..... ea ..... 18.99
- LPBF-57 ..... 1957 Front License Plate Bracket ..... ea ..... 17.99
- LPBR-56 ..... 1955-56 Rear License Plate Bracket ..... ea ..... 24.99
- LPF-56 ..... 1956 Chrome Adjustable License Plate Frame..... ea ..... 79.99
- LPL-55 ..... 1955 All & 1956-57 Nomad & Station Wagon Rear License Light Assemblies ..... pr ... 59.99
- LPL-56 ..... 1956 Rear License Light Assemblies ..... pr ... 34.99
- LPL-57 ..... 1957 Rear License Light Assembly..... ea ..... 29.99
- MH-318 ..... 1955-57 Station Wagon & Nomad License Plate Light Chrome Bezels with Screws..... pr ... 29.99



**TRI-FIVE EXHAUST**

- EXT-56 ..... 1955-56 Chrome Exhaust Extension with Emblem ..... ea ..... 44.99
- HRS-567 ..... 1957-74 2" Exhaust Manifold Heater Riser Spacer..... ea ..... 49.99
- HRV-5764 .. 1957-64 2" Exhaust Heat Riser Valve..... ea ..... 84.99

**1957 SPINNERS**

- SPR-78 ..... 1957-58 Three-Bar Wheel Spinners (4) ... set ..... 214.99
- TP1405 ... 1957-58 Wheel Spinner Center Emblem . ea ..... 18.99



**TRI-FIVE TRANSMISSION**

- PGDTU-567 .... 1955-57 Used Powerglide Transmission Dipstick & Tube Assembly..... ea ..... 79.99
- MTSL-567 ..... 1955-57 Used 3-Speed Shift Linkage ..... set ..... 99.99
- PGFW-567 ..... 1955-57 Used V8 Powerglide Trans Flywheel ..... ea ..... 119.99
- PGSL-567 ..... 1955-57 Used Powerglide Shift Linkage..... set ..... 79.99
- TLA-56 ..... 1955-56 Used PG Trans Kickdown Linkage Arm... ea ..... 49.99
- TLA-57 ..... 1957 Used PG Trans Kickdown Linkage Arm ..... ea ..... 49.99



## TRI-FIVE FUEL TANK & RELATED

GTC-56	.....1955-56 Non-Wagon Fuel Tank	..... ea	159.99
GTS-56	.....1955-56 Non-Wagon Stainless Steel Fuel Tank	..... ea	299.99
GTW-56	.....1955-56 Wagon, Nomad & Sedan Del Fuel Tank	..... ea	299.99
FF-567	.....1955-57 Fuel Filter & Bowl Assembly	..... ea	29.99
GLH-001	.....1955-57 V8 5/16" Fuel Pump Hose	..... ea	15.99
STR-567	.....1955-57 Non-Wagon Gas Tank Straps	..... pr	44.99
20-361	.....1955-57 Fuel & Brake Line Clips 7-Pc	..... set	41.99
GTSU-567	.....1955-57 Non-Wagon 5/16" Fuel Gas Tank Sending Unit	..... ea	49.99
GTSU3-567	.....1955-57 Non-Wagon 3/8" Fuel Gas Tank Sending Unit	..... ea	49.99
GTSUW-567	.....1955-57 Station Wagon, Nomad & Sedan Delivery 5/16" Gas Tank Sending Unit	..... ea	69.99
GTSUW3-567	.....1955-57 Station Wagon, Nomad & Sedan Delivery 3/8" Gas Tank Sending Unit	..... ea	69.99
GTSU9-67	.....1956-57 Wagon 5/16" Gas Tank Sending Unit	..... ea	69.99
GFTU-55	.....1955 Non-Wagon Gas Tank Filler Tube/Neck	..... ea	84.99
GFTUW-55	.....1955 Station Wagon, Nomad & Sedan Delivery Gas Tank Filler Tube/Neck	..... ea	104.99
GFT-56	.....1956 Non-Wagon Gas Tank Filler Tube	..... ea	99.99
GFTW-56	.....1956 Station Wagon (exc 9-Pass), Nomad & Sedan Delivery Gas Tank Filler Tube/Neck	..... ea	129.99
SS-1014	.....1956 Gas Filler Neck to Body Seal	..... ea	19.99
GFTL-57	.....1957 Non-Wagon Gas Tank Lower Filler Elbow	..... ea	89.99
GFTU-57	.....1957 Non-Wagon Upper Gas Tank Filler Tube/Neck	..... ea	99.99
GFTUW-57	.....1957 Station Wagon (exc 9-Pass), Nomad & Sedan Delivery Gas Tank Upper Filler Tube/Neck	..... ea	89.99
GFTW-57	.....1957 Station Wagon (exc 9-Pass), Nomad & Sedan Delivery Lower Gas Tank Filler Tube Elbow	..... ea	84.99
GTC-57	.....1957 Non-Wagon Fuel Tank	..... ea	159.99
GTS-57	.....1957 Non-Wagon Stainless Steel Fuel Tank	..... ea	299.99
GTW-57	.....1957 Wagon, Nomad & Sedan Del Fuel Tank	..... ea	299.99

## TRI-FIVE ENGINE

10-185	.....1955-57 V8 Engine Side Mounting	..... kit	94.99
DPT-5572	.....1955-72 Small Block V8 Dipstick Installation Tool	..... ea	24.99
FAMV8-567	.....1955-57 V8 Front Angle Mounts	..... pr	34.99
FMM-567	.....1955-57 Front Motor Mount Studs, Washers & Rubber	..... set	77.99
IOB-567	.....1955-67 Used SB Intake Oil Baffle Can	..... ea	34.99
NRS-5558	.....1955-58 V8 Neoprene Rear Main Oil Seals	..... set	34.99
OBC-5568	.....1955-68 Small Block V8 Oil Breather Filler Cap	..... ea	37.99
OFA6-561	.....1955-61 Used 6-Cylinder Oil Filter Assembly	..... ea	129.99
OFA8-55	.....1955 Used V8 Oil Filter Assembly	..... ea	179.99
OFC6-563	.....1950-63 Used 235 ci 6-Cylinder Oil Filter Cap	..... ea	29.99
OFH-567	.....1955-64 6-Cylinder Oil Filter Hoses	..... kit	59.99
RDT-673	.....1956-63 Used V8 Road Draft Tube	..... ea	89.99
RMMMA-567	.....1955-57 PG Auto Rear Motor Mounts	..... pr	49.99
RMMS-567	.....1955-57 Standard Shift Rear Motor Mounts	..... pr	49.99
TRTL-567	.....1955-57 Used V8 Firewall Throttle Lever	..... ea	18.99
UAC2-55	.....1955 Used 2-Barrel Oil Bath Air Cleaner Assembly	..... ea	169.99
UAC2-56	.....1956 Used 2-Barrel Oil Bath Air Cleaner Assembly	..... ea	169.99
UCU-558	.....1955-58 V8 Used "Staggered" Valve Covers	..... pr	89.99
WPP-564	.....1955-64 Used V8 Water Pump Pulley	..... ea	29.99
20-265	.....1955-57 Main Wiring Harness Clips 10-Pc	..... set	51.99
21-303	.....1955-57 V8 Coil Bracket	..... ea	17.99
EBR-56	.....1955-56 Ballast Resistor	..... ea	24.99
EBR-57	.....1957 Ballast Resistor	..... ea	24.99
EF1-56	.....1955-56 Used Engine Fan	..... ea	39.99
EF1-57	.....1957-58 Used Engine Fan	..... ea	29.99



## TRI-FIVE STEERING COLUMN

17-295	.....1955-57 Steering Column Overhaul	..... kit	30.99
17-295A	.....1955-56 Steering Column Fasteners	..... kit	30.99
17-295B	.....1957 Steering Column Fasteners	..... kit	34.99
ATI-56	.....1955-56 Used Auto Trans indicator Mechanism	..... ea	39.99
ATI-57	.....1957 Used Automatic Trans indicator Mechanism	..... ea	49.99
GSH-56	.....1955-56 Used Gear Shift Housing	..... ea	49.99
GSH-57	.....1957 Used Gear Shift Housing	..... ea	49.99
GSHM-56	.....1955-56 Custom Used Gear Shift Housing for Floor Shift	..... ea	56.99
GSHM-57	.....1957 Custom Used Gear Shift Housing	..... ea	56.99
LDB-57	.....1957 Steering Column to Dash Bracket	..... ea	36.99
LSCC-57	.....1957 Used Lower Steering Column Cover	..... ea	49.99
SCM-56	.....1955-56 Used Manual Steering Column	..... ea	149.99



SCM-57	.....1957 Used Manual Trans Steering Column	..... ea	149.99
SCA-56	.....1955-56 Used Automatic Trans Steering Column	..... ea	149.99
SCA-57	.....1957 Used Automatic Trans Steering Column	..... ea	149.99
SCB-56	.....1955-56 Upper Steering Column to Dash Brackets	..... pr	74.99
SCBS-55	.....1955-56 Chrome Steering Column Covers	..... set	129.99
SCC-567	.....1955-57 Used Steering Column Lower Shift Lever Clevis Assembly	..... ea	13.99
SCCB-57	.....1957 Lower Steering Column Cover to Dash Bracket	..... ea	25.99
TP1052	.....1955-56 Powerglide Shift Indicator Lens	..... ea	16.99
TP1054	.....1955-56 Turbo 350/400 Shift Indicator Lens	..... ea	18.99
TP1055	.....1955-56 Turbo 200/700R4 Shift Indicator Lens	..... ea	29.99
TP1490	.....1957 Powerglide Transmission Shift Indicator Lens	..... ea	19.99
TP1492	.....1957 TTH350/400 Trans Shift Indicator Lens	..... ea	19.99
TP1493	.....1957 TH-700-R4 Transmission Shift Indicator Lens	..... ea	26.99
TSH-567	.....1955-57 Used Steering Column Turn Signal Housing	..... ea	49.99
TSS-567	.....1955-57 Turn Signal Switch with Wiring	..... ea	29.99



**TRI-FIVE BRAKES**

- 567-DBS..... 1955-57 Stock Drum Brake Front Spindles ..... pr ... 224.99
- 20-361 ..... 1955-57 Fuel & Brake Line Clips 7-Pc..... set..... 41.99
- BHR-5558.... 1955-58 Rear Brake Hardware & Springs ..... kit..... 29.99
- BRS-567 .... 1955-57 Rear Brake Shoe Spreader Bar ..... ea..... 9.99
- DBB-5558 .. 1955-58 Front Disc Brake Brackets ..... set..... 79.99
- SAB-5558... 1955-58 Self-Adjusting Drum Brake Hardware ..... kit ..... 79.99
- SABR-5558..1955-58 Rear Self-Adjusting Drum Brake Hardware..kit.....49.99
- WCAB-567 .55-57 Used Front Brake Wheel Cylinder Anchor Bolt... ea..... 13.99
- EBK-5564 ... 1951-70 Car & 1951-70 Truck Rear  
Emergency Brake Shoe Levers ..... set .... 74.99
- EBA-567 ..... 1955-57 Parking/E-Brake Adjuster Assembly..... ea ..... 39.99
- EBF-567 ..... 1955-57 Emergency Brake Floor Brackets ..... pr ... 104.99
- EBH-567..... 1955-57 Black Emergency Brake Handle ..... ea..... 29.99
- EBHC-567 .. 1955-57 Chrome Emergency Brake Handle..... ea..... 29.99
- PBHC-56 ..... 1955-56 Restored Emergency Brake Handle  
Assembly with Chrome Handle..... ea..... 129.99
- PBHC-57 .... 1957 Restored Emergency Brake Handle  
Assembly with Chrome Handle..... ea..... 129.99
- PBC-567 ..... 1955-57 Parking/E-Brake Clevis Assembly ..... ea ..... 16.99
- PBH-56 ..... 1955-56 Parking/E-Brake Handle Assembly..... ea ..... 189.99
- PBH-57 ..... 1957 Parking/Emergency Brake Handle Assembly... ea ..... 189.99
- REBC-567... 1955-57 Rear Emergency Brake Cable Assembly.... ea ..... 59.99
- EBR-567 ..... 1955-57 Emergency Brake Rollers & Bolts..... set..... 24.99
- EBFB-567 ...55-57 Used Firewall Emergency Brake Roller Brackets.. pr ..... 49.99
- IDL-567 ..... 1955-57 All Except Convertible Emergency  
Brake Idler Lever Under Floor..... ea..... 19.99
- IDL-567 ... 1955-57 Convertible Emergency Brake Idler  
Lever Under Floor ..... ea..... 19.99
- FBC-567..... 1955-57 All Except Conv Front Parking Brake Cable . ea..... 24.99
- FBCC-567 .. 1955-57 Convertible Front Parking Brake Cable ..... ea..... 24.99

**TRI-FIVE SUSPENSION**

- 10-004AF.. 1955-57 Basic Front Suspension Rebuild ..... kit... 369.99
- 10-120F ..... 1955 Rear Leaf Spring Shackle Assembly (L or R) ..... ea ..... 33.99
- 10-121F ..... 1956-57 Left Rear Leaf Spring Shackle Assembly..... ea ..... 41.99
- 10-122F ..... 1956-57 Right Rear Leaf Spring Shackle Assembly..... ea ..... 41.99
- 10-123 ..... 1955-57 Short Rear Leaf Spring Shackle Bushing..... ea ..... 5.99
- 10-124 ..... 1956-57 Long Rear Leaf Spring Shackle Bushing..... ea ..... 5.99
- 10-188A..... 1955-57 Rear Axle Leaf Spring U-Bolt with Nuts ..... ea ..... 8.99
- 10-202A.... 1955-57 Left Rear Leaf Spring Shock Plate..... ea ..... 59.99
- 10-202B.... 1955-57 Right Rear Leaf Spring Shock Plate ..... ea ..... 59.99
- 10-303R.... 1955-57 Rear Axle Leaf Spring Perches ..... pr ..... 29.99
- 20-299B.... 1955-57 Front Suspension Fasteners ..... kit..... 57.99
- FCS-567 .... 1955-57 Front Coil Springs ..... pr ..... 134.99
- FCS2-567 .. 1955-57 2" Lowering Front Coil Springs..... pr ... 114.99
- LLCA-567 .. 1955-57 Left Lower Control Arm Assembly..... ea .. 139.99
- RLCA-567 .. 1955-57 Right Lower Control Arm Assembly..... ea .. 139.99
- LUCA-567 . 1955-57 Left Upper Control Arm Assembly ..... ea .. 139.99
- RUCA-567 . 1955-57 Right Upper Control Arm Assembly ..... ea .. 139.99
- RLS4-567... 1955-57 Stock 4-Leaf Rear Springs ..... pr ... 314.99
- RLS5-567... 1955-57 Stock 5-Leaf Rear Springs ..... pr ... 309.99
- RLS5L-567 . 1955-57 2" Lowering 5-Leaf Rear Springs..... pr ... 324.99
- RLS6-567 ... 1955-57 Stock 6-Leaf Heavy Duty Rear Springs ..... pr ... 399.99
- RSB-567 .... 1955-57 Rear Shock Relocation Bar ..... ea .. 129.99
- SBS-567 .... 1955-57 Used Front Spindle ..... ea .. 109.99

**TRI-FIVE FUEL DOOR**



- GDBX-57 ..... 1957 Gas Fuel Door Box with Hinges & Springs.... ea..... 89.99
- GDB-55..... 1955 Gas Door Hinge Bracket (Weld-On) ..... ea..... 49.99
- GDM-57..... 1957 Stainless Steel Gas Door Assembly ..... ea..... 109.99
- GFD-55..... 1955 Used Gas Door with Hinge ..... ea..... 89.99
- GDG-55..... 1955 Gas Door Bumpers & Hardware ..... set..... 5.99
- GDG-57..... 1957 Gas Door Bumpers & Hardware ..... set..... 14.99

**TRI-FIVE AXLES**



- AXL-56..... 1955-56 Used Left Rear "Short Side" Axle..... ea ..... 124.99
- AXL-57..... 1957 Used Left Rear "Short Side" Axle ..... ea ..... 124.99
- AXR-56 ..... 1955-56 Used Right Rear "Long Side" Axle.....ea ..... 124.99
- AXR-57 ..... 1957 Used Right Rear "Long Side" Axle .....ea ..... 124.99

**TRI-FIVE DRIVESHAFT**

- DSY-564 ..... 1955-64 Used Driveshaft Yoke..... ea ..... 69.99

**TRI-FIVE STEERING**

- SSDL-567 .... 1955-57 Restored Standard Steering  
Drag Link Center Tie Rod..... ea .. 149.99
- SSIA-567 ..... 1955-57 Restored Standard Steering Idler Arm..... ea ..... 99.99
- SSPA-567 ..... 1955-57 Used Standard Steering Pitman Arm ..... ea ..... 49.99
- PSC-567 ..... 1955-57 Power Steering Cylinder Ram..... ea ..... 179.99
- PSC-5864.... 1958-64 Power Steering Cylinder Ram..... ea .. 179.99





**TRI-FIVE STEERING WHEEL**

- 17-200..... 1955-56 Steering Wheel Horn Ring Installation..... kit ..... 25.99
- 17-201..... 1957 Steering Wheel Horn Ring Installation..... kit ..... 25.99
- 56SW ..... 1955-56 Bel Air 16" Steering Wheel Black ..... ea ... 284.99
- 57SW ..... 1957 210 & Bel Air 16" Steering Wheel Black..... ea ... 284.99
- FSW-56..... 1955-56 Bel Air 18" Steering Wheel Black..... ea ... 234.99
- FSW-57..... 1957 210 & Bel Air 18" Steering Wheel Black..... ea ... 234.99
- FSWK-56 ..... 1955-56 Bel Air Black 18" Steering Wheel .....kit.... 449.99
- FSWK-57 ..... 1957 Bel Air Black 18" Steering Wheel .....kit.... 449.99
- HBCR-57 ..... 1957 210 & Bel Air Chrome Horn Ring .....ea ..... 84.99
- HBR210-56..... 1955-56 210 Series Chrome Horn Ring .....ea ..... 99.99
- HBRBA-56..... 1955-56 Bel Air Chrome Horn Ring.....ea ..... 89.99
- HBT-56 ..... 1955-56 Bel Air Center Horn Ring Cover/Cap..... ea ..... 37.99
- HBTC-56 ..... 1955-56 Chrome Bel Air Center Horn Ring Cover/Cap..... ea ..... 57.99
- HRC-57 ..... 1957 210 & Bel Air Chrome Horn Ring Center Cap ..... ea ..... 34.99
- HRE6-56..... 1955-56 Bel Air 6-Cylinder Gold Horn Cap Emblem..... ea ..... 24.99
- HRE8-56..... 1955-56 Bel Air V8 Gold Horn Cap Emblem..... ea ..... 19.99
- HRE6210-56... 1955-56 210 Series 6-Cyl Chrome Horn Cap Emblem..... ea ..... 24.99
- HRE8210-56... 1955-56 210 Series V8 Chrome Horn Cap Emblem..... ea ..... 24.99
- SWK-56 ..... 1955-56 Bel Air Black 16" Steering Wheel ..... kit ... 469.99
- SWK-57 ..... 1957 Bel Air Black 16" Steering Wheel ..... kit ... 419.99

**TRI-FIVE HORN**

- CHC-56 .... 1955-56 Chrome Horn Cover.....ea..... 29.99

**TRI-FIVE PEDALS**

- 17-088A..... 1957 Upper Pedal Brace to Dash Mount Hardware.....kit.. 18.99
- GP-567..... 1955-57 Accelerator/Gas Pedal Assembly.... ea.. 28.99
- SBP-567..... 1955-57 Used Brake Pedal Arm..... ea.. 69.99
- SS-1051 .... 1955-57 Clutch & Brake Pedal Pad ..... ea.... 7.99

**TRI-FIVE INTERIOR SCREW SETS**

- 20-100... 1955-57 2-Door Hardtop Interior Garnish Molding Trim Screws .....set ... 14.99
- 20-101 ... 1955-57 Nomad Int. Garnish Molding Trim Screws .....set ... 15.99
- 20-102 ... 1955-57 Conv. Int. Garnish Molding Trim Screws .....set ... 14.99
- 20-103 ... 1955 2-Dr Sedan Interior Garnish Mldg Trim Screws .....set ... 14.99
- 20-104 ... 1955 4-Dr Sedan Interior Garnish Mldg Trim Screws .....set ... 14.99
- 20-105 ... 1956-57 2-Dr Sedan Interior Garnish Mldg Trim Screws..set ... 14.99
- 20-106 ... 1956-57 4-Dr Sedan Interior Garnish Mldg Trim Screws.set ... 14.99
- 20-114 ... 1955-57 Supplemental Interior Garnish Molding Trim Screws .....set ... 14.99
- 20-184... 1956-57 4-Dr HT Interior Garnish Mldg Trim Screws ..... set....14.99
- 20-185... 1955-57 2-Door Wagon Interior Garnish Molding Trim Screws.....set ... 17.99
- 20-186... 1955-57 4-Dr Wagon Int. Garnish Mldg Trim Screws..... set....18.99
- 20-201 ... 1955-57 Sedan Delivery Interior Garnish Molding Trim Screws .....set ... 19.99



**TRI-FIVE SEAT**

- CFS-56 ..... 1955-56 2-Door Complete Front Seat\* .....ea 1299.99
- CRSS-567 .... 1955-57 Conv. Rear Seat Frame\* .....set .. 999.99
- CRSB-567 .... 1955-57 Conv. Rear Seat Back Brace Structure .....ea .. 249.99
- CSK-567 ..... 1955-57 Chrome Seat Adjustment Knob .....ea ..... 9.99
- SKB-567 ..... 1955-57 Chrome Seat Adjuster Bezel .....ea ..... 23.99
- FSB-56 ..... 1955-56 2-Door Front Seat Backs Only .....pr ... 499.99
- FSC-567 ..... 1955-57 2 or 4-Door Front Seat Bottom Springs.....ea ..234.99
- FSF2-56..... 1955-56 2-Door Front Seat Foam Cushions .....set .. 289.99
- FSF2-57..... 1957 2-Door Front Seat Foam Cushions.....set .. 289.99
- FSF4-56..... 1955-56 4-Door Front Seat Foam Cushions .....set .. 289.99
- FSF4-57..... 1957 4-Door Front Seat Foam Cushions.....set .. 289.99
- USSL-56 ..... 1955-56 2-Door Bench Seat Left Upper Seat Shell ..ea .... 84.99
- USSR-56 ..... 1955-56 2-Door Bench Seat Right Upper Seat Shell...ea..... 84.99
- LSSL-56 ..... 1955-56 2-Door Bench Seat Left Lower Seat Shell...ea .... 84.99
- LSSR-56 ..... 1955-56 2-Door Bench Seat Right Lower Seat Shell...ea..... 84.99
- SSS-56..... 1955-56 2-Door Bench Seat Seat Shell 4-Pc .....set .. 299.99
- RSFC-567 .... 1955-57 Convertible Rear Seat Foam Cushions.....set .. 289.99
- RSFH-567 .... 1955-57 2-Door Hardtop Rear Seat Foam Cushions.set .. 289.99
- RSFS-567 .... 1955-57 2-Door Sedan Rear Seat Foam Cushions....set .. 289.99
- SBBH-567.... 1955-57 2-Door Hardtop Rear Seat Back Brace .....ea .. 259.99
- SBBS-567 .... 1955-57 2&4-Door Sedan Rear Seat Back Brace .....ea... 249.99
- SRLB-567 .... 1955-57 2&4-Dr Frt Bench Seat Relocation Brackets.set .. 129.99
- SSBK-567.... 1955-57 2-Door Seat Side Shell Brackets.....pr ..... 54.99
- SSS-57 ..... 1957 2-Door Seat Side Shells .....set .. 219.99
- USSL-57 ..... 1957 2-Door Frt Seat Lt Upper Seat Back Side Shell..ea .... 59.99
- USSR-57 ..... 1957 2-Door Frt Seat Rt Upper Seat Back Side Shell..ea .... 59.99
- LSSL-57 ..... 1957 2-Door Front Seat Left Lower Seat Side Shell ..ea .... 89.99
- LSSR-57 ..... 1957 2-Door Front Seat Right Lower Seat Side Shell...ea .... 89.99
- SST-56 ..... 1955-56 Seat Side Shell Stainless Trim (2 required) ..ea..... 79.99
- SST-57 ..... 1957 Seat Side Shell Stainless Trim (2 required).....ea .... 79.99
- STPR-56 ..... 1955-56 Seat Tracks with Adjuster Wire .....pr ... 269.99
- STPR-57 ..... 1957 Seat Tracks with Adjuster Wire.....pr ... 269.99
- WSBL-567.... 1955-57 Wagon & Nomad Rear Seat Back Latches ...pr ..... 59.99
- BSCC-567 .... 1955-57 2-Dr Front Bench Seat Center Pivot Cover ...ea..... 24.99



**TRI-FIVE ARMRESTS**

- ARB-57 ..... 1957 Bel Air Door Armrest Brackets.....pr ..... 59.99
- ASH-5559 ... 1955-59 Chrome Rear Armrest Ashtray Assemblies .set ..... 79.99
- HRAR-567 ... 1955-57 2-Door Hardtop Rear Armrest Bases .....pr .... 249.99
- CRAR-567... 1955-57 Conv. Rear Armrest Piston Cover Assys.....set ... 369.99





**TRI-FIVE GAUGES**

DFG-55	1955 Fuel Gauge	ea	79.99
DFG-56	1956 Fuel Gauge	ea	79.99
DFG-57	1957 Fuel Gauge	ea	79.99
DTG-56	1956 Temperature Gauge	ea	79.99
DTG-57	1957 Temperature Gauge	ea	79.99
IBS-57	1957 Instrument Cluster Gauge Chrome Bezels	set	99.99
SDB-55A	1955-56 Auto Trans Chrome Speedometer Bezel	ea	189.99
SDB-55S	1955-56 Standard Trans Chrome Speedometer Bezel	ea	189.99
TP1049	1955-56 Speedometer Lens	ea	31.99
TP1414	1957 Speedometer Face Lens	ea	37.99
TP1416	1957 Gas Gauge Lens	ea	24.99
TP1418	1957 Temperature Gauge Lens	ea	24.99

**TRI-FIVE CLOCK**

CLK-56	1955-56 Quartz Clock	ea	149.99
CLK-57	1957 Quartz Clock	ea	189.99
DCB-55	1955-56 Chrome Clock Speaker Bezel with Speaker Grille	ea	174.99
TP1056	1955-56 Clock Lens	ea	24.99

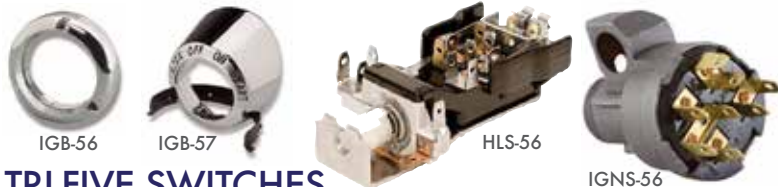

**TRI-FIVE SWITCHES**

HLS-56	1955-56 Headlight Switch	ea	43.99
HLS-57	1957 Headlight Switch	ea	44.99
IGB-56	1955-56 Chrome Ignition Switch Nut	ea	15.99
IGB-57	1957 Chrome Ignition Switch Bezel	ea	16.99
IGN-57	1957 Ignition Switch Nut	ea	10.99
IGNS-56	1955-56 Ignition Switch	ea	79.99
IGNS-57	1957 Ignition Switch	ea	79.99
DNT-567	1955-57 Dash Wiper Switch Nut & 1957 Headlight Switch Nut Tool	ea	18.99

**TRI-FIVE ASHTRAY & CIGARETTE LIGHTER**

DAT-56	1955-56 Used Dash Ashtray & Bracket	ea	69.99
DAT-57	1957 Used Dash Ashtray & Bracket	ea	69.99
CLA-55	1955 Cigarette Lighter Assembly	ea	49.99
CLA-56	1956 Cigarette Lighter Assembly	ea	49.99
CLA-57	1957 Cigarette Lighter Assembly	ea	49.99
ASH-5559	1955-59 Chrome Rear Armrest Ashtray Assemblies	set	79.99

**TRI-FIVE LOCK SETS**

21-243	1955-57 5-Pc Lock (Except Station Wagon & 1956 Hardtop/Convertible)	set	104.99
21-243B	1956 2-Door Hardtop & Convertible 5-Pc Lock	set	104.99



**TRI-FIVE DASH**

DSH-1957	1957 Complete Dash Frame Assembly	ea	499.99
TP1004	1951-58 Traffic Light Viewer	ea	59.99
ADT-55	1955 Bel Air Stock Dash Trim with Speaker Grille Script	set	174.99
DLSK-55	1955 Used Metal Dash Light Socket	ea	9.99
DLSKS-55	1955 Used Metal Dash Light Socket 7-Pc	set	49.99
WSDC-567	1955-57 Inner Dash Top Garnish Molding Center Connector	ea	9.99
CWSDC-567	1955-57 Chrome Inner Dash Top Garnish Molding Center Connector	ea	17.99
20-580A	1955-56 Dash Area Fasteners	kit	8.99
DBS-55A	1955-56 Auto Trans Chrome Dash Bezels	set	389.99
DBS-55S	1955-56 Standard Trans Chrome Dash Bezels	set	389.99
SHS215-56	1955-56 150 & 210 Series Dash Speaker Grille Chrome Script	ea	19.99
SHSBA-56	1955-56 Bel Air Dash Speaker Grille Gold Script	ea	19.99
TP1057	1955-56 Deluxe Heater Control Lens	ea	23.99
TP1058	1955-56 Deluxe Heater Control Knobs	set	12.99
TP1061	1955-56 Bel Air Dash Bezels	set	59.99
TP1062	1955-56 150 & 210 Dash Bezels	set	59.99
ADT-56	1956 Bel Air Stock Dash Trim with Speaker Grille Script	set	159.99
DC-57	1957 Dash End Caps with Screws	pr	24.99
20-229	1957 210 Dash Trim Clip	ea	1.99
ADT-57	1957 Bel Air Stock Dash Trim Set with Script	set	174.99
BADS-57	1957 Bel Air Dash Gold Script	ea	19.99
DBS-57	1957 Chrome Dash Bezels	set	62.99
CICB-57	1957 Chrome Instrument Cluster Bezel	ea	46.99
DS215-57	1957 150 & 210 Series Chrome Dash Script	ea	19.99
DSG-57	1957 Dash Speaker Grille with Hardware	ea	139.99
DSGU-57	1957 Used Dash Speaker Grille	ea	49.99
SGH-57	1957 Used Dash Speaker Grille Hardware	set	8.99
DT210-57	1957 210 Restored Stainless Steel Dash Trim w/Clips	set	249.99
TP1427	1957 Dash Bezel Indicators	set	42.99
TP1435	1957 Deluxe Heater Lens	ea	25.99
DWT-567	1955-57 Inner Lower Dash Garnish Moldings 3-Pc	set	154.99
FWPT-67	1956-57 Firewall Pad Fastener Tool	ea	16.99
FUSE-55	1955 Used Original Fuse Panel	ea	39.99
FUSE-56	1956 Used Original Fuse Panel	ea	39.99
FUSE-57	1957 Used Original Fuse Panel	ea	39.99

**TRI-FIVE RADIO**

ANT-55	1955 Radio Antenna Assembly	ea	79.99
ANT-67	1956-57 Radio Antenna Assembly	ea	79.99
RSPB-567	1955-57 Rear Deck Speaker Grille	ea	24.99
RSPC-567	1955-57 Chrome Rear Deck Speaker Grille	ea	34.99



BOPC-57



DHCC-57



BPE-356



DHBS-57



SS-1116



SS-1115



HBR-57



DHCP-55

**TRI-FIVE HEATER**

- DHCC-55... 1955 Deluxe Heater Control Cables 3-Pc ..... set..... 36.99
- DHCC-56... 1956 Deluxe Heater Control Cables 3-Pc ..... set..... 36.99
- DHCC-57... 1957 Deluxe Heater Control Cables 4-Pc ..... set..... 74.99
- DHCP-55 .... 1955 Restored Deluxe Heater Control Panel ..... ea... 399.99
- DHCP-56 .... 1956 Restored Deluxe Heater Control Panel ..... ea... 399.99
- DHCP-57 .... 1957 Restored Deluxe Heater Control Panel ..... ea... 399.99
- DHR-57 ..... 1957 Used Deluxe Heater Resistor ..... ea..... 29.99
- HBF-567 .... 1955-57 Used Heater Blower Fan "Squirrel Cage" . ea..... 59.99
- HBM-56..... 1955-56 Used Heater Blower Motor ..... ea... 134.99
- HBM-57..... 1957 Used Deluxe Heater Blower Motor ..... ea... 134.99
- HBR-57 ..... 1957 Heater Firewall Duct Retainers ..... pr ..... 29.99
- HBRC-57 .... 1957 Chrome Heater Firewall Duct Retainers..... pr ..... 44.99
- SHDP-57 .... 1957 Polished Stainless Steel Heater Delete Plate .... ea ..... 64.99
- BOPC-57.... 1957 Polished Stainless Steel Heater Control Valve Block-Off Plate ..... ea..... 20.99
- SS-1115 .... 1957 Deluxe Heater Air Inlet Hose..... ea..... 14.99
- SS-1116 .... 1957 Deluxe Heater Air Duct Sleeve ..... ea..... 8.99
- DHBS-56 .... 1955-56 Chrome Deluxe Heater Bezel ..... ea... 139.99
- DHBS-57 .... 1957 Deluxe Heater Chrome Bezels ..... set... 119.99
- RDTBSS-57 .. 1957 Stainless Steel RealDuction Tri-Block Firewall Duct Block-Off Panels with Hardware .....set ..... 69.99



FAV-57



FFAD-57

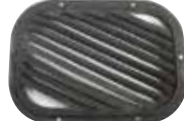

CVGUL-56

**TRI-FIVE AIR VENTS**

- FAV-57..... 1957 Fresh Air Vent Grilles..... pr..... 109.99
- FFAD-57 ..... 1957 Forward Fresh Air Duct in Fender ..... ea ..... 229.99
- CVGUL-56... 1955-56 Used Left Air Kick Panel Vent Grille..... ea ..... 29.99
- CVGUR-56 .. 1955-56 Used Right Air Vent Grille ..... ea ..... 29.99
- HBC-57 ..... 1957 Right Inner Fender Duct Block-Off ..... ea ..... 29.99
- HBCC-57 .... 1957 Chrome Right Inner Fender Duct Block-Off..... ea ..... 44.99



ISRVD-57



ISRVM-56C



IMB-567

**TRI-FIVE INSIDE REAR VIEW MIRROR**

- IMBC-567 ..... 1955-57 Convertible Chrome Inside Rear View Mirror Bracket.....ea..... 69.99
- IMB-567 ..... 1955-57 Chrome Inside Rear View Mirror Bracket...ea..... 32.99
- ISRVD-57 ..... 1957 Day/Night Mirror Adapter Bracket.....ea..... 24.99
- ISRVM-5355 ... 1953-55 Chrome Day/Night Inside Rear View Mirror .....ea..... 49.99
- ISRVM-567..... 1955-57 Chrome Inside Rear View Mirror .....ea..... 29.99
- ISRVM-56C ..... 1956 Chrome Day/Night Inside Rear View Mirror ....ea..... 64.99
- ISRVM-57 ..... 1957-62 Chrome Day/Night Inside Rear View Mirror .....ea..... 59.99



DGMSL-567



DWT-567

HRIDGL-567  
HLLIDG-567

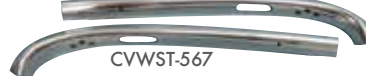

CVWST-567



CQTL-567



GMLHC-567



CVWSU-567

**TRI-FIVE INTERIOR MOLDING**

- CDS001 ..... 1955-57 Convertible Upper Inner Windshield Stainless Molding Behind Mirror Bracket ..... ea .... 32.99
- CVWST-567..... 1955-57 Conv. Upper Inner Windshield Stainless...pr .... 249.99
- CVWSU-567 .... 1955-57 Convertible Upper Inner Windshield Stainless Garnish Moldings.....pr ... 159.99
- DGMSL-567 .... 1955-57 Used 2-Door Sedan & Station Wagon Used Left Door Inner Garnish Molding ..... ea .... 99.99
- DGMSR-567 .... 1955-57 Used 2-Door Sedan & Station Wagon Used Right Door Inner Garnish Molding ..... ea .... 99.99
- QGMSL-567 .... 1955-57 Used 2-Door Sedan Used Left Quarter Inner Garnish Molding ..... ea .... 79.99
- QGMSR-567.... 1955-57 Used 2-Door Sedan Used Right Quarter Inner Garnish Molding ..... ea .... 79.99
- DWT-567 ..... 1955-57 Inner Lower Dash Garnish Moldings 3-Pc...set.... 154.99
- GSB-567 ..... 1955-57 2-Door Sedan & Station Wagon Chrome Grab Strap Bezels.....pr ..... 16.99
- HRIDGL-567 .... 1955-57 210 & Bel Air 2-Door Hardtop Restored Left Rear Stainless Inner Dogleg with Felt ..... ea .. 124.99
- HRIDGR-567.... 1955-57 210 & Bel Air 2-Door Hardtop Restored Right Rear Stainless Inner Dogleg with Felt ..... ea .. 124.99
- HLLIDG-567 .... 1955-57 Bel Air 2-Door Hardtop Restored Left Rear Stainless Inner Dogleg ..... ea .. 124.99
- HLRIDG-567.... 1955-57 Bel Air 2-Door Hardtop Restored Right Rear Stainless Inner Dogleg ..... ea .. 124.99
- QGMH-567..... 1955-57 2-Door Hardtop Rear Inner Quarter Garnish Moldings .....pr ... 179.99
- CQTL-567 ..... 1955-57 Convertible Left Rear Inner Quarter Garnish Molding.....ea .... 94.99
- CQTR-567 ..... 1955-57 Convertible Right Rear Inner Quarter Garnish Molding.....ea .... 94.99
- CWSU-567 ..... 1955-57 Convertible Upper Outer Center Windshield Stainless Molding ..... ea .. 139.99
- HCRGM-567 ... 1955-57 2-Door Hardtop Chrome Rear Inner Quarter Garnish Moldings .....pr ... 209.99
- DHBS-56 ..... 1955-56 Chrome Deluxe Heater Bezel ..... ea .. 139.99
- DHBS-57 ..... 1957 Deluxe Heater Chrome Bezel ..... set .. 119.99
- GMLHC-567 ... 1955-56 2-Door Hardtop and Convertible Left Inner Door Garnish Molding ..... ea .... 69.99
- GMRHC-567 ... 1955-56 2-Door Hardtop and Convertible Right Inner Door Garnish Molding.....ea .... 69.99
- GMPHC-567 ... 1955-56 2-Door Hardtop and Convertible Inner Door Garnish Moldings.....pr .. 209.99
- IDGMC-56 ..... 1955-56 2-Door Hardtop and Convertible Chrome Inner Door Garnish Moldings .....pr ... 179.99



SVB-567



SVBC-567

**TRI-FIVE SUNVISOR**

- SVB-567 ..... 1955-57 Chrome (Excl. Conv.) Sunvisor Brackets....pr ..... 47.99
- SVBC-567..... 1955-57 Convertible Chrome Sunvisor Brackets.....pr ... 139.99
- SVHC-5558.. 1955-58 Convertible Chrome Sunvisor Hooks.....pr ..... 49.99

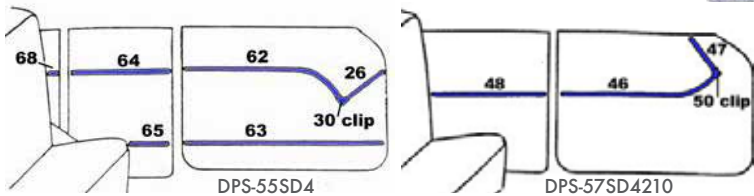

### TRI-FIVE INTERIOR SIDE PANEL STAINLESS STEEL TRIM SETS

- DPS-55CV ..... 1955 Bel Air Convertible - 12-Piece .....set .... 449.99
- DPS-55DR ..... 1955 Del Ray 2-Door Sedan - 4-Piece .....set .... 174.99
- DPS-55HT..... 1955 Bel Air 2-Door Hardtop - 12-Piece.....set .... 449.99
- DPS-55N ..... 1955 Nomad - 20-Piece .....set .... 659.99
- DPS-55SD..... 1955 Bel Air 2-Door Sedan - 12-Piece.....set .... 369.99
- DPS-55SD210 ..... 1955 210 2-Door Sedan - 4-Piece .....set .... 174.99
- DPS-55SD4 ..... 1955 Bel Air 4-Door Sedan - 14-Piece.....set .... 449.99
- DPS-56CV ..... 1956 Bel Air Convertible - 8-Piece.....set .... 349.99
- DPS-56DR ..... 1956 Del Ray 2-Door Sedan - 4-Piece.....set .... 184.99
- DPS-56HT..... 1956 Bel Air 2-Door Hardtop - 8-Piece.....set .... 349.99
- DPS-56HT210 ..... 1956 210 2-Door Hardtop - 4-Piece .....set .... 209.99
- DPS-56HT4 ..... 1956 Bel Air 4-Door Hardtop - 8-Piece.....set .... 349.99
- DPS-56HT4210 ... 1956 210 4-Door Hardtop - 4-Pc.....set .... 209.99
- DPS-56N ..... 1956 Nomad - 8-Piece .....set .... 369.99
- DPS-56SD..... 1956 Bel Air 2-Door Sedan - 8-Pc .....set .... 349.99
- DPS-56SD210 ..... 1956 210 2-Door Sedan - 4-Piece.....set .... 209.99
- DPS-56SD4 ..... 1956 Bel Air 4-Door Sedan - 10-Piece.....set .... 349.99
- DPS-57CV ..... 1957 Bel Air Convertible - 12-Piece.....set .... 449.99
- DPS-57DR ..... 1957 Del Ray 2-Door Sedan - 4-Pc .....set .... 209.99
- DPS-57HT..... 1957 Bel Air 2-Door Hardtop - 12-Piece.....set .... 449.99
- DPS-57HT4 ..... 1957 Bel Air 4-Door Hardtop - 12-Piece.....set .... 449.99
- DPS-57N ..... 1957 Nomad - 12-Piece .....set .... 449.99
- DPS-57SD..... 1957 Bel Air 2-Door Sedan - 4-Piece.....set .... 249.99
- DPS-57SD210 ..... 1957 210 2-Door Sedan - 8-Piece .....set .... 349.99
- DPS-57SD4 ..... 1957 Bel Air 4-Door Sedan - 4-Piece.....set .... 249.99
- DPS-57SD4210 ... 1957 210 4-Door Sedan - 8-Piece .....set .... 349.99

### 1955-57 CHEVY KICK PANEL WINDLACE RETAINERS

Originals are always rusty or bent (or missing!). Always. Ours are brand new, fit perfectly and unlike others on the market; they are drilled to fit 1955, 1956 & 1957 Chevy - all body styles. We manufacture them with the windlace groove wider than others to ease installation of the stubborn windlace cord.



SWLR-567... 1955-57 OE Style Windlace/Kick Panel Retainers.....pr ... 214.99

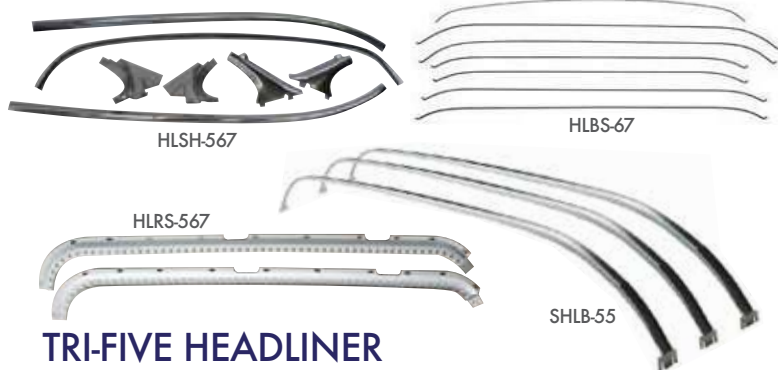

### TRI-FIVE HEADLINER

- HLBS-55 ..... 1955 2-Door Hardtop Headliner Wire Bows 3-Pc .....set .....99.99
- HLBS-67 ..... 1956-57 2-Dr Hardtop Headliner Wire Bows 7-Pc.....set ... 199.99
- HLBSD-567 .. 1955-57 2/4-Dr Sedan Headliner Wire Bows 7-Pc.....set ... 189.99
- HLRBG-567.. 1955-57 Restored Bel Air 2-Door Hardtop Rear Headliner Retainer Stainless .....ea.... 159.99
- HLRL-567 .... 1955-57 Restored Bel Air 2-Door Hardtop Left Headliner Retainer Stainless .....ea.... 169.99
- HLRR-567 .... 1955-57 Restored Bel Air 2-Door Hardtop Right Headliner Retainer Stainless .....ea.... 169.99
- HLRS-567 ..... 1955-57 2-Door Sedan, Station Wagon & Sedan Delivery Side Headliner Retainer "Sawteeth" .....pr .... 139.99
- HLRT4-567 ... 1955-57 4-Door Sedan Used Headliner Retainers "Sawteeth" .....set ... 129.99
- HLSH-567 .... 1955-57 Restored Bel Air 2-Door Hardtop Interior Headliner Stainless Trim 7-Pc.....set ... 499.99
- HLSW-567 ... 1955-57 2&4-Door Wagon Headliner Bows (9).....set ... 189.99
- HLWS-567 ... 1955-57 Used 2/4-Dr Sedan Headliner Wire Bows.....set ... 109.99
- SHLB-55 ..... 1955 Bel Air Hardtop Polished Stainless Steel Headliner Bows (3) .....set ... 629.99

### TRI-FIVE INTERIOR TACK STRIP

- 26-007 .....1955-57 2-Door Hardtop Interior Tack Strips .....set .... 79.99
- 26-008 .....1955-57 Nomad Interior Tack Strips .....set ..... 94.99
- 26-009 .....1955 2-Door Sedan Interior Tack Strips .....set ..... 64.99
- 26-010 .....1956-57 2-Door Sedan Interior Tack Strips .....set ... 49.99
- 26-011 .....1955 4-Door Sedan Interior Tack Strips .....set ... 44.99
- 26-012 .....1956-57 4-Door Sedan Interior Tack Strips.....set ... 30.99
- 26-013 .....1955-57 2-Door Wagon Interior Tack Strips .....set ... 79.99
- 26-014 .....1955-57 4-Door Wagon Interior Tack Strips .....set ... 64.99
- 26-015 .....1955-57 Sedan Delivery Interior Tack Strips.....set . 104.99



### 1957 CHEVY REALDUCTION FRESH AIR INTAKE & BLOCK-OFF SYSTEMS

Many custom car builders don't want to install those clunky original fresh air ducts that run from the headlight area back to the firewall on all 1957's. But, to eliminate them means you have holes in the firewall and no way to mount the headlights. With RealDuction, you can block off the air ducts or crate a single or dual cold-air induction system for your LS or other engine and still properly install your headlights! And get rid of those cumbersome original ducts.



- RDBB-57 ....RealDuction Blocker Front Fender & Firewall Air Duct Block-off System ..... kit ... 154.99
- RDDS-57 ...RealDuction Front Fender LS Engine 4" Dual Cold Air Induction System..... kit ...314.99
- RDFB-57 ....RealDuction Front Fender Air Duct Block-off System... kit ...119.99
- RDSS-57 ....RealDuction Front Fender LS Engine Single 4" Cold Air Induction System..... kit ...239.99
- RDTB-57 ....RealDuction Tri-Block Firewall Duct Block-off Panels .. pr .... 44.99



### TRI-FIVE DOME LIGHT

- 17-270F .... 1955-57 Small Dome Light Chrome Housing .....ea .... 35.99
- DLH-567 ... 1955-57 Large Dome Light Housing .....ea .... 29.99
- DLHL-567.. 1955-57 Large Dome Light Lens .....ea ..... 7.99
- DLHR-567.. 1955-57 Large Dome Light Chrome Ring.....ea .... 15.99
- DLS-56 ..... 1955-56 Dome Light Switch .....ea .... 24.99
- DLS-57 ..... 1957-62 Dome Light Switch .....ea .... 24.99



## BODY BOLT ADJUSTMENTS

The correct torquing of body bolts is very important. incorrect tightening can cause sill misalignment and poor door fit. Also, incorrect tightening causes many road vibrations, body creaks and other non-constant noises.



Torque body bolts in all models but convertible to 25 to 35 foot pounds. Torque convertible bolts to 10 to 12 foot pounds. Always torque body bolts before proceeding with door adjustments.

## BODY SHIMMING

In cases where door adjustments will not correct the fit of doors, the answer is body shimming. Carefull study should be made before proceeding with shimming in order not to create a new problem by trying to correct an existing one. Correct body shimming, as shown in the following examples, demonstrates basic principles of shimming, but does not necessarily show exact location of body bolts.

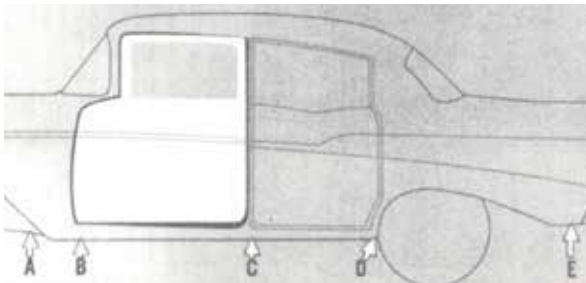

**EXAMPLE 1:** On all models except convertible - front door crowds at top and is widely spaced at the bottom near the center pillar. To correct, add shims at point "A" or reduce shims at point "B".

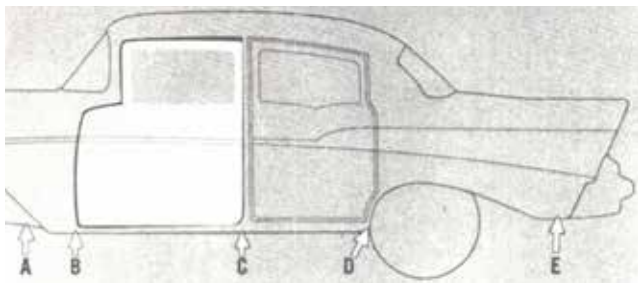

**EXAMPLE 2:** On all models except convertible - front door crowds at sill and at top of center pillar, and is widely spaced at the roof rail. To correct, add shims at point "B" or reduce shims at point "A".

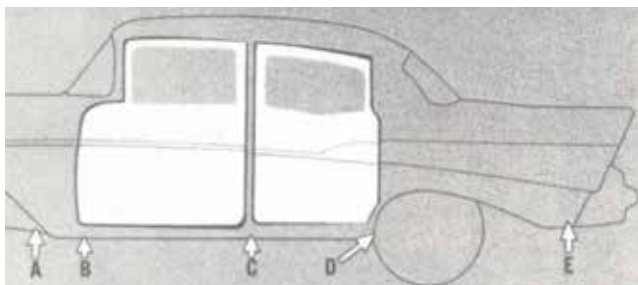

**EXAMPLE 3:** On all four door models - front door crowds at top with space at sill, and rear door crowds sill with space at top. Both doors fit correctly at hinge pillars. To correct, add shims at point "C".

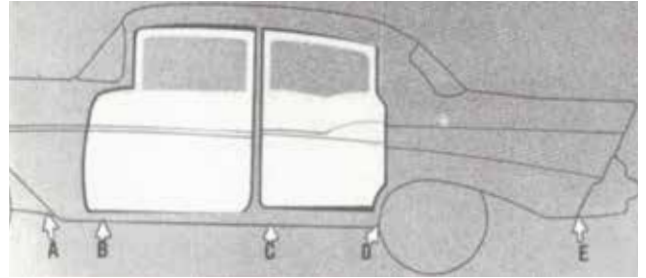

**EXAMPLE 4:** On all four door models - front door crowds sill with space at the top, and rear door crowds top with space at the sill. To correct, reduce shims at point "C" or add shims st balance of shim points.

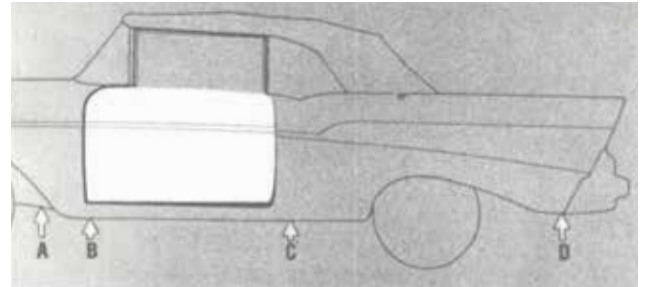

**EXAMPLE 5:** On convertibles - door crowds top and upper center pillar, leaving wide space at sill and at lower center pillar, leaving wide space at sill and at lower center pillar. To correct, add shims as required at point "C".

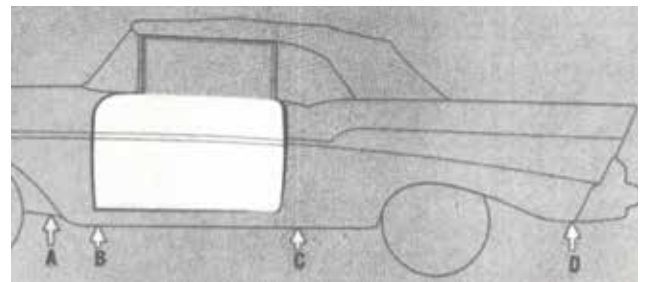

**EXAMPLE 6:** On convertibles - door crowds sill and leaves space at center pillar, tapering from wide at top to narrow at bottom. To correct, reduce shims at point "C" or add shims, as necessary, to other points.

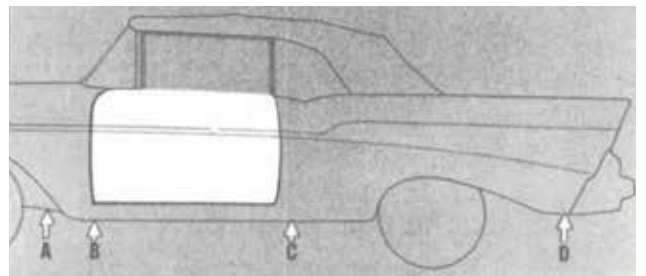

**EXAMPLE 7:** On convertibles - door crowds upper part of center pillar. To correct, add shims at points "A", "B" and "C" or reduce shims at point "D".

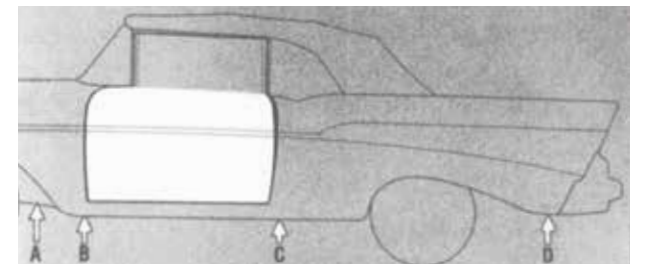

**EXAMPLE 8:** On convertibles - door crowds top, leaving space at center pillar, tapering from wide at top to narrow at bottom. To correct, add shims at point "D" as required.

# 1966-67 CHEVY-II NOVA BODIES

## 1966-67 CHEVY II/NOVA STEEL BODIES

The second-gen Chevy II has always been a favorite among X-Body enthusiasts. Small, lightweight and simple – they make excellent street and race cars. Available in 1966 or 1967 trim, our Chevy II Nova bodies are fixture welded to exacting standards to provide you with a new, rust-free beginning for your Chevy II dream build. Fully assembled in Sanford, FL USA using our 220-volt water cooled resistance spot welders – just like GM did. You can order your body stock with no shift tunnel or set up for a factory 4-speed or automatic. Want a bigger tire in the back? Opt for our Detroit Speed mini-tub option which are a full 2-1/2" wider than stock to allow for up to 315mm of rear tire.

Our Chevy II Race Car Bodies eliminate the firewall, dash, floor, trunk floor, frame rails and wheel housings. They are ready for your chassis & carbon fiber or fiberglass lightweight components. Total body weight is under 350 lbs!

**Bodies ship truck freight via body shipping table, or can be picked up in Sanford, FL with no freight charges.**



## CHEVY-II/NOVA BODIES

- N67C-1AD... 1966-67 Chevy II Body Shell Automatic Shift Bucket Seats with Quarter Panels, Top Skin, Doors & Deck Lid ..... ea ..... 14900
- N67C-1ADT. 1966-67 Chevy II Body Shell Mini-Tubbed Automatic Shift Bucket Seat with Quarter Panels, Top Skin, Doors & Deck Lid .....ea ..... 16400
- N67C-1AQ .. 1966-67 Chevy II Body Shell Automatic Shift Bucket Seats with Quarter Panels & Top Skin..... ea ..... 13400
- N67C-1AQT. 1966-67 Chevy II Body Shell Mini-Tubbed Automatic Shift Bucket Seats with Quarter Panels & Top Skin..... ea ..... 14900
- N67C-1D ..... 1966-67 Chevy II Body Shell Column Shift Bench Seat with Quarter Panels, Top Skin, & Deck Lid ..... ea ..... 14900
- N67C-1DT ... 1966-67 Chevy II Body Shell Mini-Tubbed Column Shift Bench Seat with Quarter Panels, Top Skin, Doors & Deck Lid..... ea ..... 16400
- N67C-1Q..... 1966-67 Chevy II Body Shell Column Shift Bench Seat with Quarter Panels & Top Skin..... ea ..... 13400
- N67C-1QT... 1966-67 Chevy II Body Shell Mini-Tubbed Column Shift Bench Seat with Quarter Panels & Top Skin ... ea ..... 14900
- N67C-1SD ... 1966-67 Chevy II Body Shell Standard Shift Bucket Seats with Quarter Panels, Skin, Doors & Deck Lid..... ea ..... 14900
- N67C-1SDT.. 1966-67 Chevy II Body Shell Mini-Tubbed Standard Shift Bucket Seat with Quarter Panels, Top Skin, Doors & Deck Lid..... ea ..... 16400
- N67C-1SQ... 1966-67 Chevy II Body Shell Standard Shift Bucket Seats with Quarter Panels & Top Skin..... ea ..... 13400
- N67C-1SQT. 1966-67 Chevy II Body Shell Mini-Tubbed Standard Shift Bucket Seats with Quarter Panels & Top Skin..... ea ..... 14900
- N67C-R..... 1966-67 Chevy II Race Car Body..... ea ..... 9500
- 6LT-6267-Upgrade ..... 1962-67 Chevy II/Nova Enlarged Transmission Tunnel Upgrade..... ea ..... 699

## CHEVY-II TIPS FROM THE GARAGE



### Tub Lips

Many of our 66-67 Chevy II builds feature DSE's wider wheel tubs which allow use of a 315mm rear tire. For better and easier fit, we like to leave a 1" lip on the factory inner tub and remove the flange from the DSE wider tub before installing. This creates a lap-weld situation where it is much easier to position the new wider tub to both the inner body structure and the outer wheelhouse. The wider tub can be indexed without it being "forced" into one spot (which can create huge gaps and distort the outer quarters) by the mating of the factory pinchweld flanges.



FBC-702



RBC-667

**CHEVY-II/NOVA BUMPER**

- FBC-624 ..... 1962-64 Chrome Front Bumper..... ea ....199.99
- RBC-625 ..... 1962-64 Chrome Rear Bumper ..... ea ....199.99
- FBC-65 ..... 1965 Chrome Front Bumper..... ea ....219.99
- BU02-661FB 1966-67 Front Outer Bumper Brackets..... pr .....89.99
- BU02-66FB . 1966-67 Front Inner Bumper Brackets..... pr .....79.99
- RBC-667 ..... 1966-67 Chrome Front Bumper..... ea ....199.99
- RBC-667.....1966-67 Chrome Rear Bumper..... ea ....199.99
- FBC-689 ..... 1968-69 Chrome Front Bumper..... ea ....199.99
- RBC-682 ..... 1968-72 Chrome Rear Bumper ..... ea ....179.99
- FBC-702 ..... 1970-72 Chrome Front Bumper..... ea ....179.99

**CHEVY-II/NOVA GRILLE FILLER**



- SP-672..... 1966-67 Nova Lower Grille to Bumper Filler Panel....ea.....99.99

**CHEVY-II/NOVA HOOD**

HOC-682

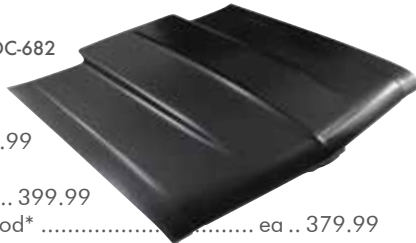

- HO-625..... 1962-65 Flat Hood\* .....ea... 299.99
- HOC-625 ..... 1962-65 2" Cowl Hood\* ..... ea ... 399.99
- HOC-672 ..... 1966-67 2" Cowl Hood\* ..... ea .. 379.99
- HOF-672 ..... 1966-67 Flat Hood\* ..... ea .. 389.99
- HOC-682 ..... 1968-72 Nova 2" Cowl Hood\* ..... ea .. 399.99

**CHEVY-II/NOVA CORE SUPPORT**



CS-672

- CS-624 ..... 1962-64 Radiator Core Support.....ea... 199.99
- CS-65 ..... 1965 Radiator Core Support .....ea... 199.99
- CS-672 ..... 1966-67 Radiator Core Support.....ea... 214.99
- CS-684 ..... 1968-74 Nova Radiator Core Support.....ea... 169.99

**CHEVY-II/NOVA FENDER**

HLB2L-67



FFL-672

- FFL-625 ..... 1962-65 Left Front Fender\* ..... ea ... 249.99
- FFR-625 ..... 1962-65 Right Front Fender\* ..... ea... 249.99
- FFL-662 ..... 1966 Left Front Fender\* .....ea....459.99
- FFR-662..... 1966 Right Front Fender\*.....ea....459.99
- HLB2L-66 .... 1966 Left Headlight Bucket/Fender Filler Assy .....ea..... 99.99
- HLB2R-66.... 1966 Right Headlight Bucket/Fender Filler Assy..... 99.99
- FFL-672 ..... 1967 Left Front Fender\* .....ea....459.99
- FFR-672..... 1967 Right Front Fender\*.....ea....459.99
- HLB2L-67 .... 1967 Left Headlight Bucket/Fender Filler Assy .....ea... 109.99
- HLB2R-67 .... 1967 Right Headlight Bucket/Fender Filler Assy ..ea... 109.99
- FBR-67 ..... 1966-67 Front Fender Brace Rod.....ea..... 19.99
- FFL-689 ..... 1968-69 Left Front Fender\* .....ea.... 369.99
- FFR-689 ..... 1968-69 Right Front Fender\* .....ea.... 369.99
- FFL-704 ..... 1970-74 Left Front Fender\* .....ea.... 349.99
- FFR-704 ..... 1970-74 Right Front Fender\* .....ea.... 349.99

**CHEVY-II/NOVA DASH**



CDA2-67

- CDA2-67 ..... 1966-67 Complete Dash Panel.....ea .. 469.99
- CDT-69 ..... 1969-74 Complete Dash Top Panel..... ea ....99.99



CVB2-67



CVG-67

**CHEVY-II/NOVA COWL**

CSL2-67



- CSL2-67 ..... 1966-67 Left Cowl Plenum Inner .... ea 109.99
- CSR2-67 ..... 1966-67 Right Cowl Plenum Inner.. ea 109.99
- OCSL2-67 ... 1966-67 Left Outer Cowl Plenum Cover .....ea..... 69.99
- OCSR2-67... 1966-67 Right Outer Cowl Plenum Cover.....ea..... 69.99
- CVB2-67 ..... 1966-67 Lower Cowl Panel ..... ea ..... 249.99
- CVG-67..... 1966-67 Upper Cowl/Grille Panel ... ea ..... 239.99
- CVG-6872 .. 1968-72 Upper Cowl Vent Grille ...ea ..... 174.99
- TCP-702 ..... 1970-72 Upper/Lower Cowl Plenum Assy..... ea .....324.99

**CHEVY-II/NOVA FIREWALL**



- FWP2-67 ..... 1962-67 Firewall\* ... ea .... 399.99
- FWBP-67 ..... 1962-67 Firewall to Floor Braces at Firewall .....pr ... 269.99

**CHEVY-II/NOVA DOOR**



UDH2-627



DOR2-67

- DOL2-66..... 1966 2-Dr Hardtop Left Door Shell\* ..ea..... 499.99
- DOR2-66 ..... 1966 2-Dr Hardtop Right Door Shell\*..... ea ....499.99
- DO02-661L .. 1966 2-Door Sedan Left Door Shell\* ..... ea ....499.99
- DO02-661R.. 1966 2-Door Sedan Right Door Shell\* ..... ea ....499.99
- DO02-671L .. 1967 2-Door Sedan Left Door Shell\* ..... ea ....499.99
- DO02-671R.. 1967 2-Door Sedan Right Door Shell\* ..... ea ....499.99
- DOL2-67 ..... 1967 2-Dr HT Left Door Shell\* ..... ea ....499.99
- DOR2-67 ..... 1967 2-Dr HT Right Door Shell\* ..... ea ....499.99
- DOL2S-625 .. 1962-65 2-Door Sedan Left Door Shell\* ..... ea ....499.99
- DOR2S-625 .. 1962-65 2-Door Sedan Right Door Shell\* ..... ea ....499.99
- DOL2-625 .... 1962-65 2-Door Hardtop Left Door Shell\*..... ea ....479.99
- DOR2-625 .... 1962-65 2-Door Hardtop Right Door Shell\* ... ea ....479.99
- LDHL2-627..... 1962-67 Left Lower Door Hinge..... ea ..... 79.99
- LDHR2-627 .... 1962-67 Right Lower Door Hinge ..... ea ..... 79.99
- UDH2-627 .... 1962-67 Left or Right Upper Door Hinge ..... ea ..... 79.99
- DOL2-682 .... 1968-72 2-Door Left Door Shell\* ..... ea ....499.99
- DOR2-682 .... 1968-72 2-Door Right Door Shell\* ..... ea ....499.99

**CHEVY-II/NOVA TOP**



TS2-67

- TS2-25 ..... 1962-65 2-Door Hardtop Top/Roof Skin Panel\* .....ea ... 479.99
- TS2-67 ..... 1966-67 2-Door Hardtop Top/Roof Skin Panel\* .....ea ... 399.99
- HTRS2-67 .. 1966-67 2-Door Hardtop Roof/Top Braces..... kit.... 269.99
- HTRF2-67 .. 1966-67 2-Door Hardtop Side Roof/Top Rails ..... pr .... 589.99

**CHEVY-II/NOVA A-PILLAR**

LAP2-67



- LAP2-67 .... 1966-67 Left Cowl Side Panel A-Pillar Assy ... 399.99
- RAP2-67 ... 1966-67 Right Cowl Side Panel A-Pillar Assy 399.99

**CHEVY-II/NOVA WINDSHIELD PILLAR**

- WSPL2-67..... 1966-67 Left Windshield Pillar..... ea ..... 49.99
- WSPR2-67 .... 1966-67 Right Windshield Pillar .... ea ..... 49.99

**CHEVY-II/NOVA BUCKET SEAT BRACKETS**

NBSMB-627



- NBSMB-627..... 1962-67 Bucket Seat Brackets ..... set .. 134.99
- NBSMB-684 ..... 1968-74 Bucket Seat Mounting Brackets ..... set.....89.99

## CHEVY-II/NOVA FLOOR PAN

NFP2-67B



- MSP-672..... 1962-67 Rear Seat Floor Pan w/Braces (Shock Brace Uninstalled)set ... 324.99
- NFP2-627 .... 1962-67 Floor Pan without Inner/Outer Rockers\* .....ea ..... 399.99
- NFP2-67B .. 1962-67 Floor Pan Complete with Bucket Seat Brackets without Inner/Outer Rockers\*ea .. 489.99
- NFP2AB-627 .. 1962-67 Floorpan w/Automatic Floor Shift w/Bucket Seats w/o Rockers\*..... ea ..... 549.99
- NFP2AT-627 ... 1962-67 Floorpan with Automatic\* Floor Shift with Bucket Seats with Toeboard. ea ..... 849.99
- NFP2T-627 ..... 1962-67 Floorpan with Column Shift Bucket Seats with Toeboard\* ..... ea ..... 729.99
- CF2-627 ..... 1962-67 Complete Floor, Trunk Floor & Frame Rail Assembly\* ..... ea ..... 1899.99
- HFPL-627 ..... 1962-67 Right Floor Panel (60"x27") ..... ea ..... 109.99
- HFPR-627 ..... 1962-67 Right Floor Panel (60"x27") ..... ea ..... 109.99
- NFP2-684 ..... 1968-74 Complete Floor Pan\* ..... ea ..... 439.99
- HFPL-684 ..... 1968-74 Left Floor Panel ..... ea ..... 99.99
- HFPR-684 ..... 1968-74 Right Floor Panel ..... ea ..... 99.99
- RSP-684 ..... 1968-74 Nova Under Rear Seat Floor Panel ea ..... 129.99

## CHEVY-II/NOVA TRANSMISSION TUNNEL

- FPTA-627 .... 1962-67 Nova Automatic Trans Floor Tunnel Cover ea .... 59.99
- FPTS-627 .... 1962-67 Nova Standard Trans Floor Tunnel Cover ea .... 59.99
- 6LT-6267 .... 1962-67 Enlarged Transmission Tunnel..... ea ... 399.99
- FPTS-684 .... 1968-74 Standard Trans Floor Tunnel Cover ..... ea ..... 74.99

## CHEVY-II/NOVA ROCKER PANEL

LHR02-627



- LHR02-627 .... 1962-67 2-Door Left Outer Rocker Panel ..... ea ..... 99.99
- RHR02-627 .... 1962-67 2-Door Right Outer Rocker Panel..... ea ..... 99.99
- LHR2-67 ..... 1966-67 2-Door Left Complete Rocker Panel ..... ea ... 269.99
- RHR2-67 ..... 1966-67 2-Door Right Complete Rocker Panel...ea ... 269.99
- LIR-682 ..... 1968-72 Left Inner Rocker Panel..... ea ..... 89.99
- RIR-682 ..... 1968-72 Right Inner Rocker Panel..... ea ..... 89.99
- LHR2-682 ..... 1968-72 2-Door Left Outer Rocker Panel ..... ea ... 149.99
- RHR2-682 ..... 1968-72 2-Door Right Outer Rocker Panel..... ea ... 149.99

## CHEVY-II/NOVA REAR BODY PANEL

TLP2C-67



- TLP2C-624... 1962-64 Rear Body Taillight Panel Complete..... ea ... 329.99
- TLP2C-67..... 1966-67 Rear Body Panel Complete ..... ea ..... 389.99
- TLP2L-67..... 1966-67 Left Taillamp Mounting Panel..... ea ..... 74.99
- TLP2R-67 ..... 1966-67 Right Taillamp Mounting Panel..... ea ..... 74.99
- TLP2-689 ..... 1968-69 Rear Body Taillight Panel ..... ea ..... 139.99
- TLP2-702 ..... 1970-72 Rear Body Taillight Panel ..... ea ..... 134.99

## CHEVYII/NOVA DECK LID

- TL2-67 ..... 1966-67 Deck Lid\* ..... 399.99
- TL2-684... 1968-74 Deck Lid\* ..... 259.99



## CHEVY-II/NOVA PACKAGE TRAY

RPTS2-67

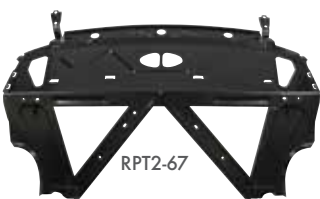

- RPT2-67... 1966-67 2-Door Hardtop Rear Package Shelf/Seat Back/Trunk Hinge Structure\* ..... set...499.99
- RPTS2-67. 1966-67 Rear Package Tray Lower Brace Supports ..... pr.....59.99

## CHEVY II/NOVA QUARTER PANEL



- LHQP2-625.... 1962-65 2-Door Hardtop Left Full Qtr Panel\* .....ea... 299.99
- RHQP2-625.... 1962-65 2-Door Hardtop Right Full Qtr Panel\*.....ea... 299.99
- QP02-62L ..... 1962-65 2-Door Left Qtr Panel Skin\*.....ea... 189.99
- QP02-62R ..... 1962-65 2-Door Right Qtr Panel Skin\* .....ea... 189.99
- LHQP2-67 ..... 1966-67 2-Door Hardtop Left Full Quarter Panel\* .ea... 489.99
- RHQP2-67..... 1966-67 2-Door Hardtop Right Full Qtr Panel\*.....ea... 489.99
- LIQP2-67 ..... 1966-67 2-Door Hardtop Left Inner Qtr Panel.....ea... 369.99
- RIQP2-67 ..... 1966-67 2-Door Hardtop Right Inner Qtr Panel .....ea... 369.99
- QP02-66L ..... 1966-67 2-Door Left Qtr Panel Skin\*.....ea... 199.99
- QP02-66R ..... 1966-67 2-Door Right Qtr Panel Skin\* .....ea... 199.99
- LHQP2-689 .... 1968-69 2-Door Left Full Quarter Panel\* .....ea... 499.99
- RHQP2-689.... 1968-69 2-Door Right Full Quarter Panel\* .....ea... 499.99
- LHQP2-702.... 1970-72 2-Door Left Full Quarter Panel\*.....ea... 479.99
- RHQP2-702... 1970-72 2-Door Right Full Quarter Panel\* .....ea... 479.99
- QP02-70L ..... 1970-72 2-Door Left Qtr Panel Skin\*.....ea... 149.99
- QP02-70R ..... 1970-72 2-Door Right Qtr Panel Skin\* .....ea... 149.99
- QP02-731L .... 1973-74 2-Door Left Qtr Panel Skin\* .....ea... 149.99
- QP02-731R.... 1973-74 2-Door Right Qtr Panel Skin\* .....ea... 149.99

## CHEVY II/NOVA WHEELHOUSE

- OWHL-672 .... 1966-67 Left Outer ea..... 109.99
- OWHR-672 .... 1966-67 Right Outer ea..... 109.99



## CHEVY-II/NOVA DECK FILLER

- DP2-67 ..... 1966-67 2-Door Hardtop Rear Deck Filler Panel..... ea .... 89.99
- DP2-682... 1968-72 Rear Deck Filler Panel ..... ea .. 109.99



## CHEVY-II/NOVA TRUNK

TFC-672



- TF2-627 ..... 1962-67 Complete Trunk Floor & Frame Rail Assembly\* ... 1499.99
- TFC-627 ..... 1962-67 Trunk Floor w/Gas Tank Braces & Straps\* ..ea ... 379.99
- TFDA2L-67 ... 1966-67 Left Trunk Floor Drop-off .....ea ..... 59.99
- TFDA2R-67 ... 1966-67 Right Trunk Floor Drop-off.....ea ..... 59.99

## CHEVY-II/NOVA BODY SIDES

- LBSA2-67 ..... 1966-67 2-Door Hardtop Left Body Side Assy\* ... set.. 1679.99
- RBSA2-67 .... 1966-67 2-Door Hardtop Right Body Side Assy\* .set.. 1679.99



## CHEVY-II/NOVA FRAME

- LRFR2-67 .... 1962-67 Chevy II Left Rear Frame Rail .....ea....249.99
- RRFR2-67 .... 1962-67 Chevy II Right Rear Frame Rail.....ea....249.99
- FRBL2-67 .... 1966-67 Chevy II Left Rear Diagonal Brace.....ea.....44.99
- FRBR2-67 .... 1966-67 Chevy II Right Rear Diagonal Brace .....ea.....44.99
- LRTB2-67 .... 1962-67 Chevy II Left Rear Torque Box/ Forward Leaf Spring Perch .....ea.....69.99
- RRTB2-67 .... 1962-67 Chevy II Right Rear Torque Box/ Forward Leaf Spring Perch .....ea.....69.99



# 1967-73 CAMARO BODIES

## 1967-69 CAMARO COUPE BODIES

America's (& possibly the world's!) ultimate muscle car – period. The first-gen Camaro body is our most popular. All are skinned using 18-gauge exterior skins – far better than the flimsy 20-gauge panels that others use! Ask your bodyman – he'll tell you the big difference. Available with factory AC firewall, stock heater firewall or heater delete and stock tubs or our wider wheel tubs which allow up to 335mm of rear tire! Also now available with the popular DSE Quadralink rear crossmember installed.

Our Camaro Race Car Bodies eliminate the firewall, dash, floor, trunk floor, frame rails and wheel housings. These bodies are ready for your chassis and carbon fiber or fiberglass lightweight components. Total weight under 350 lbs!

**Bodies ship truck freight via body shipping table, or can be picked up in Sanford, FL with no freight charges.**



Assembled in the USA  
with Real Steel!



## 1967-69 CAMARO BODIES

- C67C-14.....1967 Camaro Coupe Complete with Stock Heater Firewall, Top Skin, Drip Rails, Quarter Panels, Doors & Deck Lid .ea.... 17000
- C67C-14HD...1967 Camaro Coupe Complete with Heater Delete Firewall, Top Skin, Drip Rails, Quarter Panels, Doors & Deck Lid .ea.... 17000
- C67C-R.....1967 Camaro Race Car Body..... ea..... 9500
- C68C-14.....1968 Camaro Coupe Complete with Stock Heater Firewall, Top Skin, Drip Rails, Quarter Panels, Doors & Deck Lid .ea.... 17000
- C68C-14AC...1968 Camaro Coupe Complete with Factory A/C Firewall, Top Skin, Drip Rails, Quarter Panels, Doors & Deck Lid .ea.... 17000
- C68C-14HD...1968 Camaro Coupe Complete with Heater Delete Firewall, Top Skin, Drip Rails, Quarter Panels, Doors & Deck Lid .ea.... 17000
- C68C-R.....1968 Camaro Race Car Body..... ea..... 9500
- C69C-14.....1969 Camaro Coupe Complete with Stock Heater Firewall, Top Skin, Drip Rails, Quarter Panels, Doors & Deck Lid .ea.... 17000
- C69C-14AC...1969 Camaro Coupe Complete with Factory A/C Firewall, Top Skin, Drip Rails, Quarter Panels, Doors & Deck Lid .ea.... 17000
- C69C-14HD...1969 Camaro Coupe Complete with Heater Delete Firewall, Top Skin, Drip Rails, Quarter Panels, Doors & Deck Lid...ea.... 17000
- C69C-R.....1969 Camaro Race Car Body..... ea..... 9500
- C69C-5.....1967-1969 Camaro & Firebird Mini-Tub Option .ea..... 1000
- 6LT-789-Upgrade...1967-69 Enlarged Trans Tunnel Upgrade .ea..... 699

## 1967-69 FIREBIRD BODIES

- F789F-14.....1967-69 Firebird Coupe Complete with Top Skin, Drip Rails, Quarter Panels, Doors & Deck Lid (Specify Year) ..ea..... 17000

## 1967-69 CAMARO/FIREBIRD DSE QUADRALINK INSTALLATION

- DSE-QDK789 .... 1967-69 RDS Coupe Factory Installed Upgrade Using your Provided Detroit Speed Kit #041703-S (If RDS Provides Kit, Add \$3,100) ea..... 1200



## 70-73 Camaro

### 1970-73 CAMARO BODIES



- C70C-R..... 1970-73 Camaro Race Car Body ..... ea..... 9500
- C7073C-1HD..... 1970-73 Camaro Coupe Body with Automatic & Heater Delete Firewall ..... ea... 15500
- C7073C-1HDWWT ..... 1970-73 Camaro Coupe Body w/Auto & Heater Delete Firewall w/DSE Wider Wheel Tubs .. ea... 16500
- C7073C-1.... 1970-73 Camaro Coupe Body with Automatic & Stock Heater Firewall ..... ea... 15500
- C7073C-1WWT .. 1970-73 Camaro Coupe Body with Auto & Stock Heater Firewall with DSE Wider Wheel Tubs ..... ea... 16500
- C7073C-1AC ..... 1970-73 Camaro Coupe Body with Automatic & Factory Air Conditioning Firewall ..... ea... 15500
- C7073C-1ACS .... 1970-73 Camaro Coupe Body with Standard Transmission & Factory Air Conditioning Firewall ..... ea... 15500
- C7073C-1ACWWT ..... 1970-73 Camaro Coupe Body with Automatic & Factory Air Conditioning Firewall with DSE Wider Wheel Tubs..... ea.... 16500
- C7073C-1ACSWWT ... 1970-73 Camaro Coupe Body w/Standard Trans & Factory A/C Firewall w/DSE Wider Wheel Tubs ..... ea... 16500
- C7073C-1HDS.... 1970-73 Camaro Coupe Body with Standard Transmission & Heater Delete Firewall ..... ea... 15500
- C7073C-1HDSWWT... 1970-73 Camaro Coupe Body w/Manual Trans & Heater Delete Firewall w/DSE Wider Wheel Tubs.... ea... 16500
- C7073C-1S..... 1970-73 Camaro Coupe Body with Standard Transmission & Stock Heater Firewall ..... ea... 15500
- C7073C-1SWWT.... 70-73 Camaro Coupe Body with Standard Trans & Stock Heater Firewall with DSE Wider Wheel Tubs... ea... 16500
- 6LT-7081-Upgrade . 1970-81 Camaro & Firebird Enlarged Transmission Tunnel Upgrade ..... ea..... 699



# 1970-81 FIREBIRD BODIES



Assembled in the USA with Real Steel!

## 1970-81 FIREBIRD COUPE BODIES

Bodies ship truck freight via body shipping table, or can be picked up in Sanford, FL with no freight charges.

## 1970-81 FIREBIRD BODIES

F7073C-1S.....	1970-73 Firebird Coupe Body with Standard Transmission & Stock Heater Firewall .....	ea ... 14500
F7073C-1HDS....	1970-73 Firebird Coupe Body with Standard Transmission & Heater Delete Firewall .....	ea ... 14500
F7073C-1ACS....	1970-73 Firebird Coupe Body with Standard Transmission & Factory A/C Firewall .....	ea ... 14500
F7073C-1.....	1970-73 Firebird Coupe Body with Automatic & Stock Heater Firewall .....	ea ... 14500
F7073C-1HD .....	1970-73 Firebird Coupe Body with Automatic & Heater Delete Firewall.....	ea ... 14500
F7073C-1AC.....	1970-73 Firebird Coupe Body with Automatic & Factory A/C Firewall .....	ea ... 14500
F7578C-1.....	1975-78 Firebird Coupe Body with Automatic & Stock Heater Firewall .....	ea ... 14500
F7578C-1HD .....	1975-78 Firebird Coupe Body with Automatic & Heater Delete Firewall.....	ea ... 14500
F7578CS-1.....	1975-78 Firebird Coupe Body with Standard Transmission & Stock Heater Firewall .....	ea ... 14500
F7578CS-1HD....	1975-78 Firebird Coupe Body with Standard Transmission & Heater Delete Firewall .....	ea ... 14500
F7578C-1WWT ..	1975-78 Firebird Coupe Body with Automatic & Stock Heater Firewall with DSE Wider Wheel Tubs .....	ea ... 15500
F7578C-1HDWWT ...	1975-78 Firebird Coupe Body with Automatic & Heater Delete Firewall with DSE Wider Wheel Tubs .....	ea ... 15500
F7578CS-1WWT .....	1975-78 Firebird Coupe Body with Manual Trans & Stock Heater Firewall w/DSE Wider Wheel Tubs .....	ea ... 15500
F7578CS-1HDWWT .	1975-78 Firebird Coupe Body w/Manual Trans & Heater Delete Firewall with DSE Wider Wheel Tubs... ..	ea ... 15500
F7981C-1.....	1979-81 Firebird Coupe Body with Automatic & Stock Heater Firewall .....	ea ... 14500
F7981C-1HD .....	1979-81 Firebird Coupe Body with Automatic & Heater Delete Firewall.....	ea ... 14500
F7981CS-1.....	1979-81 Firebird Coupe Body with Manual Transmission & Stock Heater Firewall .....	ea ... 14500
F7981CS-1HD....	1979-81 Firebird Coupe Body with Manual Transmission & Heater Delete Firewall .....	ea ... 14500
F7981C-1WWT .....	1979-81 Firebird Coupe Body with Automatic & Stock Heater Firewall w/DSE Wider Wheel Tubs ..	ea ... 15500
F7981C-1HDWWT ...	1979-81 Firebird Coupe Body with Automatic & Heater Delete Firewall with DSE Wider Wheel Tubs ..	ea ... 15500
F7981CS-1WWT .....	1979-81 Firebird Coupe Body with Manual Trans & Stock Heater Firewall with DSE Wider Wheel Tubs ..	ea ... 15500
F7981CS-1HDWWT...	1979-81 Firebird Coupe Body w/Manual Trans & Heater Delete Firewall with DSE Wider Wheel Tubs ...	ea..... 15500

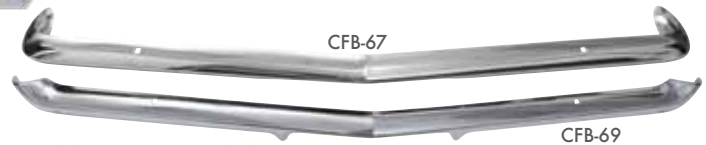

## CAMARO BUMPER

CFB-67.....	1967 Chrome Front Bumper.....	ea .... 199.99
CFB-68.....	1968 Chrome Front Bumper.....	ea .... 199.99
CFB-69.....	1969 Chrome Front Bumper.....	ea .... 199.99
CRB-678...	1967-68 Chrome Rear Bumper.....	ea.... 199.99
CRB-69.....	1969 Chrome Rear Bumper.....	ea.... 199.99

## 1967-73 CAMARO FRONT VALANCE



125-3567-1 ...	1967-68 Non-RS Front Lower Valance Panel .....	ea ..... 89.99
125-3567-2 ...	1967 RS Front Lower Valance Panel.....	ea ..... 99.99
125-3568-2 ...	1968 RS Front Lower Valance Panel.....	ea ..... 84.99
125-3569.....	1969 Front Lower Valance .....	ea ..... 84.99
K-327536.....	1970-73 Camaro Standard Front Lower Valance Panel .	224.99
125-3570-2 ...	1970-73 Camaro RS Front Lower Valance Panel	ea... 299.99

## 1967-69 CAMARO FRONT SPOILER



CSK-78.....	1967-68 Front Spoiler .....	kit..... 74.99
CSK-69.....	1969 Front Spoiler.....	kit..... 69.99

## 1967-77 CAMARO CORE SUPPORT



350-3567 .....	1967-68 Radiator Core Support .....	ea ..... 149.99
350-3569 .....	1969 Radiator Core Support.....	ea ..... 159.99
350-3570.....	1970-73 Radiator Core Support .....	ea ..... 199.99
CS01-74.....	1974-77 Radiator Core Support .....	ea ..... 399.99

## 1967-69 CAMARO BATTERY



BT-789.....	1967-69 Battery Tray .....	ea ..... 36.99
-------------	----------------------------	----------------

## 1967-73 CAMARO HEADER PANEL



130-3567 .....	1967-68 Front Header Panel.....	ea.... 79.99
130-3569.....	1969 Front Header Panel.....	ea.. 104.99
130-3570-1 ...	1970-73 Camaro Standard Front Header Panel ...	ea.. 249.99
130-3570-2 ...	1970-73 Camaro RS Front Header Panel .....	ea.. 259.99

**1967-81  
CAMARO/  
FIREBIRD  
FIREWALL**

All Firewalls except FP01-683F include both lower torque boxes



- FP01-671F.... 1967 with Factory Air Conditioning Firewall\* ..... ea ... 369.99
- FP01-672F.... 1967 Heater Delete Complete Firewall\* ..... ea ... 369.99
- FP01-67F..... 1967 with Stock Heater Complete Firewall\* ..... ea ... 369.99
- FP01-691F.... 1968-69 with Factory Air Conditioning Firewall\* .....ea ... 369.99
- FP01-692F.... 1968-69 Heater Delete Complete Firewall\* ..... ea ... 369.99
- FP01-69F..... 1968-69 with Stock Heater Complete Firewall\* ..... ea ... 369.99
- FP01-683F.... 1968-69 "Smoothie" Firewall\* ..... ea ... 369.99
- FP01-67FEL .. 1967-69 Left Forward Torque Box Assembly  
at Base of Firewall ..... ea ..... 79.99
- FP01-67FER.. 1967-69 Right Forward Torque Box  
Assembly at Base of Firewall ..... ea ..... 79.99
- FP11-781F.... 1975-81 Firebird Heater Delete Complete Firewall\* .ea ... 519.99
- FP11-782F.... 1975-81 Firebird Stock Heater Complete Firewall\* .ea ... 449.99
- FP01-75TB.... 1975-81 Full Length Toeboard Panel..... ea ... 259.99
- FP01-75TBL.. 1975-81 Left Toeboard Panel..... ea ... 109.99
- FP01-75TBR.. 1975-81 Right Toeboard Panel ..... ea ... 109.99

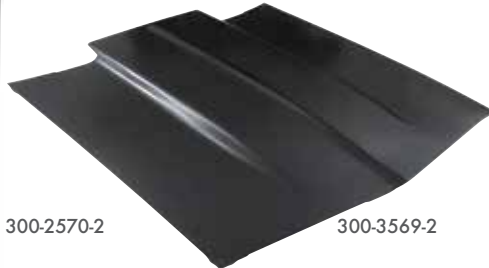

**1967-81 CAMARO HOOD**

- 300-3567..... 1967-69 SS Hood\* .....ea ... 379.99
- 300-3569-2 .... 1967-69 2" Cowl Induction Hood\*.....ea ... 269.99
- 300-3569-4 .... 1967-69 4" Cowl Induction Hood\*.....ea ... 329.99
- W-218..... 1967-68 Hood Latch Support..... ea ..... 26.99
- W-220..... 1969 Hood Latch Support .....ea ..... 32.99
- 300-3570-2 .... 1970-81 Camaro 2" Cowl Induction Hood\* ea ..... 429.99
- HO01-70L..... 1970-73 Camaro Vertical Hood Latch Support.ea ..... 29.99

**CAMARO  
FRONT END  
SHEET METAL  
PACKAGES**

These high-quality kits include: core support, top cowl grille, left & right fenders with extensions, a pair of fender diagonal braces, header panel, hood (choice of 2" cowl, 4" cowl or SS), hood latch support, left & right inner fenders and lower valance panel. Available in RS or non-RS configurations.



- 1967FEP.....1967 Non-RS Complete Front End Sheet Metal Pkg\*....1699.99
- 1967FEP-RS ..1967 RS Complete Front End Sheet Metal Package\*.....1699.99
- 1968FEP.....1968 Non-RS Complete Front End Sheet Metal Pkg\*....1699.99
- 1968FEP-RS ..1968 RS Complete Front End Sheet Metal Package\*....1699.99
- 1969FEP.....1969 Non-RS Complete Front End Sheet Metal Pkg\*....1699.99
- 1969FEP-RS ..1969 RS Complete Front End Sheet Metal Package\*....1699.99
- 197073FEP...70-73 Non-RS Complete Front End Sheet Metal Package\*. 1599.99
- 197073FEP-RS ... 1970-73 Camaro RS Complete Front End Sheet Metal Package\* ..... 1699.99



**1967-81  
CAMARO/  
FIREBIRD  
COWL**

- 360-3567....1967 Upper/Lower Cowl Plenum Assembly  
without Factory A/C.....ea ..... 389.99
- 360-3568....1968 Upper/Lower Cowl Plenum Assembly  
without Factory A/C.....ea ..... 389.99
- 360-3569....1969 Upper/Lower Cowl Plenum Assembly  
without Factory A/C.....ea ..... 389.99
- CP01-671.... 1967-69 Top Cowl Vent Grille Panel.....ea ..... 149.99
- CP01-67L.... 1967-69 Left Outer Cowl Plenum Assembly .....ea ..... 124.99
- CP01-67R.... 1967-69 Right Outer Cowl Plenum Assembly .....ea ..... 124.99
- FP01-781F.... 1975-81 Camaro & Firebird Heater Delete Firewall . ea .. 499.99
- FP01-782F.... 1975-81 Camaro & Firebird Factory A/C Firewall\* .. ea .. 499.99
- FP01-78F..... 1975-81 Camaro & Firebird Stock Heater Firewall\* . ea .. 499.99
- APRKL-781.... 1970-81 Camaro & Firebird Left Windshield  
Pillar Repair Kit..... ea .. 129.99
- APRKR-781 ... 1970-81 Camaro & Firebird Right Windshield  
Pillar Repair Kit..... ea .. 129.99
- CP01-70..... 1970-73 Camaro Dash Top w/Top Cowl Panel ..... ea .. 209.99
- 360-3570..... 1970-81 Camaro/Firebird Lower Cowl Plenum ..... ea ... 384.99
- FP01-70FHD. 1970-73 Camaro Heater Delete Firewall\* ..... ea .. 389.99
- FP01-70F..... 1970-73 Camaro Stock Heater Firewall\*..... ea .. 359.99
- CP01-70L..... 1970-73 Camaro Left Outer Cowl Panel..... ea .... 49.99
- CP01-70R..... 1970-73 Camaro Right Outer Cowl Panel ..... ea .... 49.99

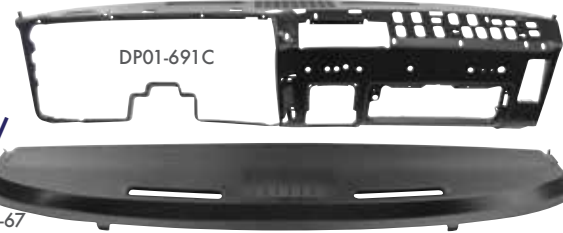
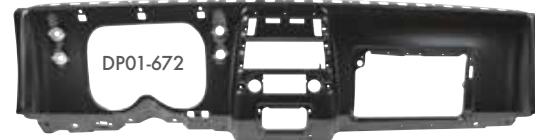

**CAMARO/  
FIREBIRD  
DASH**

- CDT-67..... 1967 Camaro/Firebird Dash Top Panel.....ea ..... 99.99
- CDT-68..... 1968 Camaro/Firebird Dash Top Panel.....ea ..... 99.99
- CDT-69..... 1969 Camaro Dash Top Panel.....ea ..... 99.99
- DP01-672..... 1967 Camaro/Firebird Dash without Factory Air .....ea ... 299.99
- DP01-673C .. 1967 Camaro/Firebird Dash with Factory Air ..... ea ... 299.99
- DP01-682C .. 1968 Camaro/Firebird Dash without Factory Air .....ea ... 299.99
- DP01-691C.. 1969 Camaro Complete Dash ..... ea ... 389.99
- DP01-692C.. 1969 Firebird Complete Dash.....ea ... 299.99



- HLTSF-789 ... 1967-69 Forward Headliner Tack Strips ...pr ... 74.99
- HLTSR-789 ... 1967-69 Rear Headliner Tack Strips (3)...set ... 99.99
- HLTSF-773 ... 1970-73 Forward Headliner Tack Strip.... ea ... 69.99
- HLTSR-773... 1970-73 Rear Headliner Tack Strip ..... ea ... 79.99



### 1967-74 CAMARO/ FIREBIRD ROOF

- 1004H..... 1967-69 Coupe Forward Drip Rail Extensions ..... pr ..... 99.99
- 600-3567 . 1967-69 Coupe Roof/Top Skin Panel\* ..... ea ... 299.99
- DM01-67L.... 1967-69 Coupe Left Roof/Top Drip Rail..... ea ... 104.99
- DM01-67S.... 1967-69 Stainless Steel Drip Rail Moldings 6-Pc ... set ..... 99.99
- DM01-67R.... 1967-69 Coupe Right Roof/Top Drip Rail..... ea ... 104.99
- RF01-67B .... 1967-68 Coupe Top/Roof Braces ..... kit.... 269.99
- RF01-69B .... 1969 Coupe Top/Roof Braces..... kit.... 249.99
- RF01-70S..... 1970-74 Camaro Top Skin/Structure Assembly\* ... ea ...999.99



### 1967-81 CAMARO FENDER

- 200-3567-1LS ...1967 RS Left Front Fender w/Extension\* ..... ea ... 329.99
- 200-3567-1RS ...1967 RS Right Front Fender w/Extension\* ..... ea ... 329.99
- 200-3567-LS.....1967 Non-RS Left Front Fender w/Extension\* .... ea ... 329.99
- 200-3567-RS .....1967 Non-RS Right Front Fender w/Extension\* .. ea ... 329.99
- 200-3568-1LS ...1968 RS Left Front Fender w/Extension\* ..... ea ... 329.99
- 200-3568-1RS ...1968 RS Right Front Fender w/Extension\* ..... ea ... 329.99
- 200-3568-LS.....1968 Non-RS Left Front Fender w/Extension\* .... ea ... 329.99
- 200-3568-RS .....1968 Non-RS Right Front Fender w/Extension\* .. ea ... 329.99
- 200-3569-LS.....1969 Left Front Fender w/Extension\* ..... ea ... 329.99
- 200-3569-RS .....1969 Right Front Fender w/Extension\* ..... ea ... 329.99
- CFEL-78 .....1967-68 Left Front Fender Extension ..... ea ..... 42.99
- CFER-78 .....1967-68 Right Front Fender Extension..... ea ..... 42.99
- CFEL-69 .....1969 Left Front Fender Extension ..... ea ..... 42.99
- CFER-69 .....1969 Right Front Fender Extension ..... ea ..... 42.99
- W-656 .....1967-69 Front Fender to Core Support Braces.. pr..... 21.99
- 200-3570-L .....1970-77 Camaro Left Front Fender\* ..... ea ... 359.99
- 200-3570-R.....1970-77 Camaro Right Front Fender\* ..... ea ... 359.99
- FE01-70P .....1970-81 Front Fender to Core Support Braces.. pr..... 29.99

### 1967-69 CAMARO/ FIREBIRD CONVERTIBLE



- 67CTC.....1967-69 Convertible Top Hydraulic Cylinder (2 reqd)....ea .. 129.99
- 67CTK .....1967-69 Convertible Top Hydraulic Hoses .....set .... 79.99
- 67CTMP ..... 1967-69 Conv Top Hydraulic Pump & Motor Assembly. ea .. 399.99
- CTFC-789 ...1967-69 Convertible Power Top Frame Assembly\* ...ea 1199.99

### 1967-69 CAMARO/ FIREBIRD A-PILLAR



- DHPL-89... 1968-69 Left A-Pillar Assembly with Hinge Mounts ..... ea .....399.99
- DHPR-89 .. 1968-69 Right A-Pillar Assembly with Hinge Mounts ... ea..... 399.99

### 1967-69 CAMARO/ FIREBIRD CHASSIS



- RS-SPEC-789\* .. 1967-69 ROADSTER SHOP SPEC Chassis ..... ea 10,899.99

### CAMARO/FIREBIRD FRAME



- CSF-67 .....1967 Front Subframe\* ..... ea. 1429.99
- CSF-68 .....1968 Front Subframe\* ..... ea. 1429.99
- CSF-69 .....1969 Front Subframe\* ..... ea 1429.99
- FR01-67L.....1967 Left Rear Frame Rail .... ea... 199.99
- FR01-67R .....1967 Right Rear Frame Rail..... ea ..... 199.99
- FR01-68L.....1968 Left Rear Frame Rail ..... ea ..... 199.99
- FR01-68R .....1968 Right Rear Frame Rail..... ea ..... 199.99
- FR01-69L.....1969 Left Rear Frame Rail ..... ea ..... 199.99
- FR01-69R .....1969 Right Rear Frame Rail..... ea ..... 199.99
- FR01-70L .....1970-73 Camaro Left Rear Frame Rail..... ea ..... 299.99
- FR01-70R .....1970-73 Camaro Right Rear Frame Rail..... ea ..... 299.99
- RTBL-7081 ....1970-81 LR Forward Spring Perch/Torque Box.... ea ..... 109.99
- RTBR-7081 ....1970-81 RR Forward Spring Perch/Torque Box.... ea ..... 109.99
- FR01L-7481 ..1974-81 Left Complete Rear Frame Rail..... ea ..... 699.99
- FR01R-7481 .1974-81 Right Complete Rear Frame Rail ..... ea ..... 699.99



### 1967-81 CAMARO INNER FENDER

- 250-3567-L..... 1967-68 Left Inner Fender\* ..... ea .... 139.99
- 250-3567-R..... 1967-68 Right Inner Fender\* ..... ea .... 139.99
- 250-3569-1L..... 1969 RS Left Inner Fender\* ..... ea .... 154.99
- 250-3569-1R..... 1969 RS Right Inner Fender\* ..... ea .... 154.99
- 250-3569-L..... 1969 Non-RS Left Inner Fender\* ..... ea .... 149.99
- 250-3569-R..... 1969 Non-RS Right Inner Fender\* ..... ea .... 149.99
- 250-3570-L..... 1970-81 Camaro Left Front Inner Fender ..... ea .... 149.99
- 250-3570-R..... 1970-81 Camaro Right Front Inner Fender ..... ea .... 149.99

### 1967-81 CAMARO/ FIREBIRD SEAT



- DP01-67RSB ...1967-69 Coupe Rear Seat Back Braces .....pr .... 79.99
- SRLBD-789 ..... 1967-69 Left Front Bucket Seat Relocation Brackets ... set.....79.99
- SRLBP-789 ..... 1967-69 Right Front Bucket Seat Relocation Brackets. set.....79.99
- RSBP-7081 ..... 1970-81 Rear Seat Back Panel with Seat Hooks..... ea .... 99.99

### 1967-69 CAMARO/FIREBIRD BODY MOUNTS



- BMKSC-672.... 1967-72 Frame to Body Mounts (includes bolts & washers).....kit. 59.99



### CAMARO/ FIREBIRD SUSPENSION

- RLSCM-6769 .... 1967-69 4-Leaf Rear ..... pr ... 324.99
- RLSCN-6772 .... 1967-69 Mono-Leaf ..... pr ... 299.99
- RLSCN-7081 .... 1970-81 Mono-Leaf ..... pr ... 289.99
- RSM-7073 ..... 1970-73 Rear Upper Shock Mounts ..... pr ... 279.99
- RSM-7481 ..... 1974-81 Rear Upper Shock Mounts ..... pr ... 279.99



**CAMARO/FIREBIRD DOOR**

DO01-70L	DO01-69HL	DO01-691HL	DO01-691HR
DO01-671HL.....1967 Left Lower Door Hinge .....	ea	79.99	
DO01-671HR.....1967 Right Lower Door Hinge.....	ea	79.99	
DO01-67HL.....1967 Left Upper Door Hinge.....	ea	49.99	
DO01-67HR.....1967 Right Upper Door Hinge .....	ea	49.99	
525-3568-L.....1968 Left Lower Door Hinge .....	ea	41.99	
525-3568-R.....1968 Right Lower Door Hinge.....	ea	41.99	
520-3568-L.....1968 Left Upper Door Hinge.....	ea	41.99	
520-3568-R.....1968 Right Upper Door Hinge .....	ea	41.99	
DO01-691HL.....1969 Left Lower Door Hinge .....	ea	59.99	
DO01-691HR.....1969 Right Lower Door Hinge.....	ea	59.99	
DO01-69HL.....1969 Left Upper Door Hinge.....	ea	49.99	
DO01-69HR.....1969 Right Upper Door Hinge .....	ea	49.99	
DO01-69SET.....1969 Door Hinges (4) .....	set	199.99	
DO01-67L.....1967 Coupe/Conv Left Door Shell* .....	ea	489.99	
DO01-67R.....1967 Coupe/Conv Right Door Shell* .....	ea	489.99	
DO01-68L.....1968 Coupe/Conv Left Door Shell* .....	ea	489.99	
DO01-68R.....1968 Coupe/Conv Right Door Shell*.....	ea	489.99	
500-3569-L.....1969 Coupe/Conv Left Door Shell* .....	ea	389.99	
500-3569-R.....1969 Coupe/Conv Right Door Shell* .....	ea	389.99	
DO01-70L.....1970-74 Camaro Left Door Shell* .....	ea	799.99	
DO01-70R.....1970-74 Camaro Right Door Shell* .....	ea	799.99	
DO01-70HL.....1970-81 Left Upper Door Hinge.....	ea	69.99	
DO01-70HR.....1970-81 Right Upper Door Hinge.....	ea	69.99	
DO01-701H.....1970-81 Left Or Right Lower Door Hinge.....	ea	49.99	
DO11-75L.....1975-81 Firebird Left Door Shell* .....	ea	699.99	
DO11-75R.....1975-81 Firebird Right Door Shell* .....	ea	699.99	



**1967-81 CAMARO/FIREBIRD ROCKER PANEL**

440-3567-1L... 1967-69 Left Inner Rocker Forward Ext.....	ea	41.99
440-3567-1R... 1967-69 Right Inner Rocker Forward Ext .....	ea	41.99
440-3567-L..... 1967-69 Left Inner Rocker Panel .....	ea	59.99
440-3567-R..... 1967-69 Right Inner Rocker Panel.....	ea	59.99
450-3569-VL... 1967-69 Conv Left Inner/Outer Rocker Panel Assby ea	499.99	
450-3569-VR... 1967-69 Conv Right Inner/Outer Rocker Panel Assby ea	499.99	
RP01-67L..... 1967-69 Left Outer Rocker Panel .....	ea	99.99
RP01-67R..... 1967-69 Right Outer Rocker Panel.....	ea	99.99
RP01-70LS..... 1970-81 Camaro Left Inner/Outer Rocker		
Assembly With A-Pillar* .....	ea	324.99
RP01-70RS..... 1970-81 Camaro Right Inner/Outer Rocker		
Assembly With A-Pillar* .....	ea	399.99
450-3570-L..... 1970-81 Left Outer Rocker Panel .....	ea	99.99
450-3570-R..... 1970-81 Right Outer Rocker Panel.....	ea	99.99
440-3570-L..... 1970-81 Left Inner Rocker Panel .....	ea	99.99
440-3570-R..... 1970-81 Right Inner Rocker Panel.....	ea	99.99

**1967-69 CAMARO/FIREBIRD FULL FLOOR & TRUNK FLOOR ASSEMBLIES**

Floor assemblies are assembled here in Sanford, FL. They act as a rigid "fixture" when repairing your damaged original car because the firewall, inner quarters and trunk drop-offs only fit one way. You are assured of a nice, square, true repair. Available for coupe, convertible, stock rear configuration or modified for mini-tubs!



CFF-7..... 1967 Coupe Full Floor with Trunk & Braces* .....	ea	2089.99
CFF-8..... 1968 Coupe Full Floor with Trunk & Braces* .....	ea	2089.99
CFF-9..... 1969 Coupe Full Floor with Trunk & Braces* .....	ea	2089.99
CFFC-7..... 1967 Conv Full Floor with Trunk & Braces* .....	ea	2624.99
CFFC-8..... 1968 Conv Full Floor with Trunk & Braces* .....	ea	2624.99
CFFC-9..... 1969 Conv Full Floor with Trunk & Braces* .....	ea	2624.99
CFFCT-7..... 1967 Convertible Full Floor with Braces		
& Trunk Floor Tubbed for Wider Wheel Wells*.....	ea	2834.99
CFFCT-8..... 1968 Convertible Full Floor with Braces		
& Trunk Floor Tubbed for Wider Wheel Wells*.....	ea	2834.99
CFFCT-9..... 1969 Convertible Full Floor with Braces		
& Trunk Floor Tubbed for Wider Wheel Wells*.....	ea	2834.99
CFFT-7..... 1967 Coupe Full Floor with Braces		
& Trunk Floor Tubbed for Wider Wheel Wells*.....	ea	2299.99
CFFT-8..... 1968 Coupe Full Floor with Braces		
& Trunk Floor Tubbed for Wider Wheel Wells*.....	ea	2299.99
CFFT-9..... 1969 Coupe Full Floor with Braces		
& Trunk Floor Tubbed for Wider Wheel Wells*.....	ea	2299.99
CFF-7073 .. 1970-73 Full Floor w/Trunk, Braces & Frame Rails*ea	2699.99	
CFFT-7073 1970-73 Full Floor with Trunk, Braces & Frame Rails		
Tubbed for DSE Wider Wheel Tubs* .....	ea	2999.99



**1967-81 CAMARO/FIREBIRD FLOOR PAN**

405-3567-L..... 1967-69 Left Half Full Floor Pan* .....	ea	94.99
405-3567-R..... 1967-69 Right Half Full Floor Pan* .....	ea	94.99
400-3567..... 1967-69 Coupe & Conv Floor Pan with Braces* .....	ea	379.99
425-3567-L..... 1967-69 Conv. Left Front Floor Under Support..	ea	69.99
425-3567-R..... 1967-69 Conv. Right Front Floor Under Support..	ea	69.99
425-3567-V..... 1967-69 Conv. Main Center Floor Support .....	ea	139.99
CFPC-789..... 1967-69 Conv. Floorpan with Under Braces* .....	ea	1449.99
FP01-67SBL..... 1967-69 Coupe Left Front Seat Platform .....	ea	69.99
FP01-67SBR..... 1967-69 Coupe Right Front Seat Platform.....	ea	69.99
FP01-67TBL..... 1967-69 Left Toeboard Repair Panel .....	ea	69.99
FP01-67TBR..... 1967-69 Right Toeboard Repair Panel.....	ea	69.99
RSFP-789..... 67-69 Camaro/Firebird Full Rear Seat Floor Pan .....	ea	89.99
W-441..... 1967-69 Convertible Center Floor X-Brace.....	ea	89.99
CRFBL-789..... 1967-69 Conv. Left Rear Seat Floor Brace.....	ea	59.99
CRFBR-789..... 1967-69 Conv. Right Rear Seat Floor Brace.....	ea	59.99
472-3569-R..... 1967-69 Conv Right Floor to Firewall Brace .....	ea	64.99
472-3569-L..... 1967-69 Conv Left Floor To Firewall Brace .....	ea	64.99
FP01-702..... 1970-74 Coupe Floor with Braces		
(Can be Modified to fit 75-81)* .....	ea	749.99
FP01-70H..... 1970-81 Camaro Manual Trans Tunnel .....	ea	49.99
FP01-70U..... 1970-81 Rear Seat Under Floorpan.....	ea	209.99
FP01-751L..... 1975-81 Left Half Full Floor Pan* .....	ea	79.99
FP01-751R..... 1975-81 Right Half Full Floor Pan* .....	ea	79.99
FP01-752..... 1975-81 Floor Pan with Braces .....	ea	699.99

**1967-81 CAMARO/FIREBIRD ENLARGED TRANS TUNNEL**

Custom 16-gauge steel tunnel is 37" long, comes fully formed, welded & ready to install! Enlarged nearly 2" to allow easy installation of GM 4L60, 4L80, 6L80, 6L90, 8L & 10L transmissions. Designed for stock firewall. Requires cutting, welding & fabrication skills to install. A stock front bench seat may require modification to fit in tunnel area, but bucket seats are okay! Works with stock console with additional fabrication.



6LT-789..... 1967-69 Enlarged Transmission Tunnel.....	ea	399.99
6LT-7081..... 1970-81 Enlarged Transmission Tunnel.....	ea	399.99

## 1967-70 CAMARO/FIREBIRD PACKAGE TRAY



X657-3567-S

DP01-68S

- DP01-68S.....1967-69 Coupe Rear Package Tray.....ea .. 199.99
- X657-3567-S.....1967-69 Rear Package Tray Extensions.....pr ..... 69.99
- 640-3570.....1970-73 Rear Package Tray .....ea .. 234.99
- 640-3570-L.....1970-73 Left Rear Package Tray Extension.....ea .... 49.99
- 640-3570-R.....1970-73 Right Rear Package Tray Extension.....ea .... 49.99

DF01-70

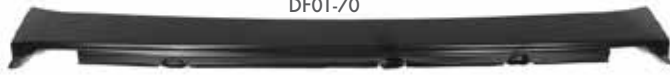

## 1967-69 CAMARO/FIREBIRD DECK FILLER

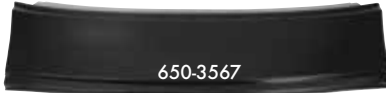

650-3567

- 650-3567 .....1967-69 Coupe Rear Deck Filler Panel.....ea..... 99.99
- DFPC-789 .....1967-69 Convertible Rear Deck Filler Panel.....ea..... 79.99
- DFPCU-789 ....1967-69 Convertible Lower Deck Filler  
Torsion Bar Support with Hinges .....ea..... 249.99
- TL01-70.....1970-81 Camaro & Firebird Deck Lid.....ea..... 189.99
- DF01-701.....1970-81 Rear Deck Filler Inner Panel .....ea..... 74.99
- DF01-70.....1970-81 Rear Deck Filler Panel.....ea..... 69.99

900-3570

900-3567-1

## 1967-81 CAMARO/FIREBIRD TAILLIGHT/REAR VALANCE

- 810-3567 .....1967-68 Camaro/Firebird Inner  
Taillight Panel Center Brace .....ea..... 59.99
- 900-3567 .....1967-68 Camaro Rear Body Taillight Panel.....ea.... 149.99
- 900-3567-1 .1967-68 Camaro RS Rear Body Taillight Panel .....ea.... 149.99
- 900-5567 .....1967-68 Firebird Rear Body Taillight Panel .....ea.... 309.99
- VP01-671R...1967-68 Camaro/Firebird Rear Lower Valance Panel ea..... 99.99
- 900-5569.....1969 Firebird Taillight Panel.....ea..... 299.99
- VP01-691R...1969 Camaro/Firebird Rear Lower Valance Panel . ea..... 94.99
- TP01-69 .....1969 Camaro Rear Body Taillight Panel .....ea.... 154.99
- TP01-694 .....1969 Camaro/Firebird Inner Tailpan Center Brace ea..... 49.99
- 900-3570....1970-73 Camaro Taillight Panel .....ea..... 159.99
- TF01-70RC..70-73 Camaro Rear Inner Cross Rail Valance Panel.ea ..... 109.99
- 871-3570-L..1970-73 Left Rear Body Valance Filler Panel.....ea..... 24.99
- 871-3570-R..1970-73 Right Rear Body Valance Filler Panel .....ea..... 24.99
- TLPF-7073 ....1970-73 Firebird Rear Body Taillight Panel .....ea.... 179.99
- TP11-74 .....1974-78 Firebird Rear Body Taillight Panel.....ea.... 349.99
- 920-5579-L..1979-81 Firebird Lt Quarter to Taillight Filler Panel ea..... 49.99
- 920-5579-R..1979-81 Firebird Rt Quarter to Taillight Filler Panel ea..... 49.99
- TLPF-7981 ...1979-81 Firebird Taillight Panel.....ea..... 499.99

## 1967-69 CAMARO/FIREBIRD MINI TUBS

- WWTI-789.....1967-69 Mini-Tubs .....pr .... 259.99



### REAL DEAL STEEL:

1220 East 30th Street | Sanford, FL 32773  
Store Hours: 8:00am - 5:00pm EDT | Tel: 407-585-1957  
Email: info@realdealsteel.com | www.realdealsteel.com



QPCV67L\*

QP69CCPR\*

700-3570-L

WH01-702L

## 1967-81 CAMARO/FIREBIRD QUARTER PANEL

- 700-3567-L...1967 Camaro Coupe Left Full Quarter Panel\* ..... ea... 349.99
- 700-3567-R...1967 Camaro Coupe Right Full Quarter Panel\*.... ea... 349.99
- QP11-67LOE...1967 Firebird Coupe Left Full Quarter Panel\*..... ea... 399.99
- QP11-67ROE ..1967 Firebird Coupe Right Full Quarter Panel\* .. ea... 399.99
- QPCV67-L.....1967 Camaro Conv. Left Full Quarter Panel\* ..... ea... 429.99
- QPCV67-R.....1967 Camaro Conv. Right Full Quarter Panel\* ..... ea... 429.99
- QP11-671LOE...1967 Firebird Conv. Left Full Quarter Panel\*..... ea... 499.99
- QP11-671ROE ..1967 Firebird Conv. Right Full Quarter Panel\* .. ea... 499.99
- 700-3568-L...1968 Camaro Coupe Left Full Quarter Panel\*..... ea... 349.99
- 700-3568-R...1968 Camaro Coupe Right Full Quarter Panel\*.... ea... 349.99
- QP11-68LOE...1968 Firebird Coupe Left Full Quarter Panel\*..... ea... 399.99
- QP11-68ROE ..1968 Firebird Coupe Right Full Quarter Panel\* .. ea... 399.99
- QPCV68-L.....1968 Camaro Convertible Left Full Quarter Panel\* . ea... 369.99
- QPCV68-R.....1968 Camaro Conv. Right Full Quarter Panel\* ..... ea... 369.99
- QP11-681LOE...1968 Firebird Conv. Left Full Quarter Panel\*..... ea... 499.99
- QP11-681ROE ..1968 Firebird Conv. Right Full Quarter Panel\* .. ea... 499.99
- 700-3569-L...1969 Camaro Coupe Left Full Quarter Panel\*..... ea... 329.99
- 700-3569-R...1969 Camaro Coupe Right Full Quarter Panel\*..... ea... 329.99
- QP11-69LOE...1969 Firebird Coupe Left Full Quarter Panel\*..... ea... 399.99
- QP11-69ROE ..1969 Firebird Coupe Right Full Quarter Panel\* .. ea... 399.99
- QPCV69-L.....1969 Camaro Convertible Left Full Quarter Panel\* . ea... 369.99
- QPCV69-R.....1969 Camaro Conv. Right Full Quarter Panel\* ..... ea... 369.99
- QP11-691LOE...1969 Firebird Conv. Left Full Quarter Panel\*..... ea... 499.99
- QP11-691ROE ..1969 Firebird Conv. Right Full Quarter Panel\* .. ea... 499.99
- W-975L .....1967-68 Coupe Left QP Stiffener at Trunk Hinge .....ea.....24.99
- W-975R.....1967-68 Coupe Right QP Stiffener at Trunk Hinge....ea.....24.99
- W-976L .....1969 Coupe Left QP Stiffener at Trunk Hinge .....ea.....19.99
- W-976R.....1969 Coupe Right QP Stiffener at Trunk Hinge .....ea.....19.99
- W-654.....1967-69 Coupe Quarter Window Stiffeners .....pr.....27.99
- QPFL-7073....1970-73 Firebird Left Full Quarter Panel\* .....ea... 579.99
- QPFR-7073 ...1970-73 Firebird Right Full Quarter Panel\*.....ea... 579.99
- 700-3570-L...70-73 Camaro Full OE Style Left Quarter Panel\* .. ea... 429.99
- 700-3570-R...70-73 Camaro Full OE Style Right Quarter Panel\* ea... 429.99
- WH01-702L .....1970-74 Camaro/Firebird Left Inner  
Quarter with B-Pillar & Outer Wheelhouse\*.....ea... 699.99
- WH01-702R.....1970-74 Camaro/Firebird Right Inner  
Quarter with B-Pillar & Outer Wheelhouse\*.....ea... 699.99
- 700-5575-L...1975-81 Firebird Left Full Quarter Panel\* .....ea... 459.99
- 700-5575-R ..1975-81 Firebird Right Full Quarter Panel\*.....ea... 459.99

## 1967-69 CAMARO/FIREBIRD INNER QUARTER STRUCTURE

- QP01-672L .....1967-69 Coupe Left Inner  
Quarter Structure\*...ea .429.99
- QP01-672R.....1967-69 Coupe Right Inner  
Quarter Structure\*...ea ..... 429.99





**1967-81 CAMARO/  
FIREBIRD TRUNK**

800-3567 ....	1967 Coupe Trunk Floor* ea.....	299.99
800-3568 ....	1968 Coupe Trunk Floor* ea.....	369.99
800-3569 ....	1969 Coupe Trunk Floor* .....	ea..... 369.99
850-3567 ....	1967-69 Trunk Deck Lid.....	ea..... 259.99
851-3567 ....	1967-68 Camaro Rear Spoiler with Template.....	ea..... 139.99
851-3569 ....	1969 Camaro Rear Spoiler with Template.....	ea..... 139.99
CKSB-78.....	1967-68 Conv Trunk Cocktail Shaker Brackets.....	pr ..... 299.99
CKSB-9.....	1969 Conv Trunk Cocktail Shaker Brackets .....	pr ..... 299.99
THB-6769....	1967-69 Trunk Hinge to Inner Wheelhouse Brackets..	pr ..... 49.99
TL01-67HP..	1967-69 Trunk Hinges.....	pr ..... 169.99
TL01-693....	1969 Trunk to Quarter Braces.....	pr ..... 18.99
TL01-671S...	1967-69 Trunk Weatherstripping Gutters .....	set ..... 69.99
TF01-67TB...	1967-69 Rear Axle Snubber Bracket on Trunk Floor..	ea..... 39.99
TF01-67DL..	1967-68 Left Trunk Floor Drop off Panel .....	ea..... 49.99
TF01-67DR..	1967-68 Right Trunk Floor Drop-off Panel.....	ea..... 49.99
TF01-69DL..	1969 Left Trunk Floor Drop-off Panel .....	ea..... 44.99
TF01-69DR..	1969 Right Trunk Floor Drop-off Panel.....	ea..... 44.99
TFA-67C.....	1967 Convertible Assembled Trunk Floor & Frame Rail Assembly.....	ea... 1189.99
TFA-67CT ....	1967 Conv. Assembled Trunk Floor & Frame Rail Assembly Narrowed for DSE Mini Tubs.....	ea... 1489.99
TFA-67.....	1967 Coupe Assembled Trunk Floor & Frame Rail Assembly.....	ea..... 989.99
TFA-67T.....	1967 Coupe Assembled Trunk Floor & Frame Rail Assembly Narrowed for DSE Wider Wheel Tubs .....	ea... 1289.99
TFA-68C.....	1968 Convertible Assembled Trunk Floor & Frame Rail Assembly.....	ea... 1189.99
TFA-68CT ....	1968 Conv. Assembled Truck Floor & Frame Rail Assembly Narrowed for DSE Mini Tubs.....	ea... 1489.99
TFA-68.....	1968 Coupe Assembled Trunk Floor & Frame Rail Assembly.....	ea..... 989.99
TFA-68T.....	1968 Coupe Assembled Trunk Floor & Frame Rail Assembly Narrowed for DSE Wider Wheel Tubs .....	ea... 1289.99
TFA-69C.....	1969 Conv. Assembled Trunk Floor & Frame Rail Assembly.....	ea... 1189.99
TFA-69CT ....	1969 Conv. Assembled Trunk Floor & Frame Rail Assembly Narrowed for DSE Mini Tubs.....	ea... 1489.99
TFA-69.....	1969 Coupe Assembled Trunk Floor & Frame Rail Assembly.....	ea..... 989.99
TFA-69T.....	1969 Coupe Assembled Trunk Floor & Frame Rail Assembly Narrowed for DSE Wider Wheel Tubs .....	ea... 1289.99
TFA-70.....	1970-73 Coupe Assembled Trunk Floor & Frame Rail Assembly* .....	ea... 1199.99
TFA-70T.....	1970-73 Coupe Assembled Trunk Floor & Frame Rail Assembly Narrowed for DSE Wider Wheel Tubs* .....	ea... 1499.99
TFDPL-7073.	1970-73 Firebird Left Trunk Floor Drop Off Panel...	ea..... 69.99
TFDPR-7073	1970-73 Firebird Right Trunk Floor Drop Off Panel	ea..... 69.99
TF01-74DL..	1974-81 Left Trunk Floor Drop Off Panel .....	ea..... 59.99
TF01-74DR..	1974-81 Right Trunk Floor Drop Off Panel.....	ea..... 59.99
TL01-701S...	1970-73 Camaro Trunk Gutters.....	pr ..... 79.99
K-K251 .....	1970-73 Camaro & Firebird Trunk Lock Support ..	ea ..... 54.99
TF01-70 .....	1970-73 Camaro Trunk Floor*.....	ea ..... 449.99
840-3570-L.	1970-73 Camaro Left Trunk Floor Drop Off Panel	ea ..... 39.99
840-3570-R.	1970-73 Camaro Right Trunk Floor Drop Off Panel.	ea ..... 39.99
TL01-70HL ..	1970-81 Camaro/Firebird Left Trunk Hinge .....	ea ..... 104.99
TL01-70HR..	1970-81 Camaro/Firebird Right Trunk Hinge .....	ea ..... 84.99

**CAMARO TIPS FROM THE GARAGE**

**Floating Wheelhouses**

Fitting the outer quarter panels on a 67-69 Camaro is a battle. If the outer wheelhouses are attached to the inner body first, you have painted yourself into a corner. So many things have to fit just right in order to get good door, glass, rocker, trunk & taillight panel gaps & fit. One way to ease this fitment process is to let the outer wheelhouses "float" when installing new quarters. Place the wheelhouses in between the inner body structure & the outer quarters but don't screw or weld them yet. Floating the wheelhouses will let you change their position until the outer quarters fit well. Once the fit is satisfactory, attach the wheelhouses to the outer quarter openings & weld that seam first. Then weld to the inner body structure.



**Pull the Sails**

Another area of difficulty when fitting the quarters on a 67-69 Camaro is creating a nice, even door gap. When the quarters are test fit, often the door gap will be good at the bottom but much too wide at the top. To fix, the quarter must be pulled ahead at the top while it is anchored with tech screws at the bottom. We simply attach a pair of vice-grips & pull the quarter ahead & into place with a cheap ratchet strap.



**CAMARO/  
FIREBIRD  
WHEELHOUSE**



WH01-671L.....	1967 Left Rear Inner Wheelhouse .....	ea..... 79.99
WH01-671R .....	1967-69 Right Rear Inner Wheelhouse .....	ea..... 79.99
WH01-67L.....	1967-68 Left Rear Outer Wheelhouse.....	ea..... 69.99
WH01-67R .....	1967-68 Right Rear Outer Wheelhouse .....	ea..... 69.99
WH01-681L.....	1968-69 Left Rear Inner Wheelhouse.....	ea..... 79.99
WH01-69L.....	1969 Left Rear Outer Wheelhouse .....	ea..... 79.99
WH01-69R .....	1969 Right Rear Outer Wheelhouse.....	ea..... 79.99
OWHFL-7081 ....	1970-81 Firebird Left Outer Wheelhouse.....	ea..... 124.99
OWHFR-7081....	1970-81 Firebird Right Outer Wheelhouse.....	ea..... 124.99

**1947-59  
CHEVY/GMC  
TRUCK  
FIREWALL**



RFWT-5559LS ...	1955-59 Chevy & GMC Truck Recessed Smoothie Steel Firewall for LS/LT Engines .....	ea..... 499.99
RFWT-5559.....	1955-59 Chevy & GMC Truck Recessed Smoothie Steel Firewall for Small Block Chevy with Distributor ..	ea..... 499.99
ETT-5559 .....	1955-59 Chevy & GMC Truck Enlarged Transmission Tunnel .....	ea..... 299.99
EFK-5559 .....	1955-59 Chevy & GMC Truck Extended Floor Pan Kit.....	set ... 169.99
RFWT-4754.....	1947-55 (First Series) Chevy & GMC Truck Recessed Smoothie Firewall.....	ea..... 499.99



**REAL DEAL STEEL  
100% COTTON  
BLACK T-SHIRTS**

RDSTM.....	Medium .....	22.99
RDSTL.....	Large .....	22.99
RDSTXL.....	XL .....	22.99
RDSTXXL .....	XXL .....	25.99
RDSTXXXL ..	XXXL.....	25.99



CGMU-53

**1949-54 GRILLE**

- CGMC-49 ... 1949-50 Chrome Center Grille Molding.....ea. . 359.99
- CGMC-54 ... 1954 Chrome Center Grille Molding.....ea. . 359.99
- CGML-49 .... 1949-50 Chrome Lower Grille Molding.....ea. . 294.99
- CGMU-49 ... 1949-50 Chrome Upper Grille Molding .....ea. . 294.99
- CGMU-53 ... 1953 Chrome Upper Grille Molding.....ea. . 359.99
- LGM-53..... 1953 Chrome Lower Grille Molding .....ea. . 359.99
- TCCGM-53 .... 1953 Chrome Top Center Grille Molding.....ea. . 359.99
- CGMU-54 ... 1954 Chrome Upper Grille Molding.....ea. . 359.99

**1949-53 SPLASH PAN**



RUP-4950

- FSP-49 ..... 1949-50 Front Splash Pan ..... 284.99
- RVP-4950..... 1949-50 Rear Bumper Filler Panel ..... 159.99
- FSP-53 ..... 1953 Front Splash Pan ..... 284.99

**1949-54 BATTERY**

- BT-4954..... 1949-54 Battery Tray.....ea.....54.99



IRPL-54

**1949-52 INNER ROCKER PANEL**

- IRPL-49 ..... 1949-52 Left Inner Rocker Panel .....ea. . 104.99
- IRPR-49 ..... 1949-52 Right Inner Rocker Panel.....ea. . 104.99
- IRPL-54 ..... 1953-54 Left Inner Rocker Panel .....ea. . 74.99
- IRPR-54 ..... 1953-54 Right Inner Rocker Panel.....ea. . 74.99

**1949-50 CHEVY WHEELHOUSE**

- RWPL-49.....1949-50 Left Rear.. ea..... 299.99
- RWPR-49 ...1949-50 Right Rear ea..... 299.99



**1949-54 GAS TANK BRACES**



GTBL-49

- GTBL-49 ...1949-52 Left Gas Tank Brace Under Trunk Floor .....ea. .... 74.99
- GTBR-49 ...1949-52 Right Gas Tank Brace Under Trunk Floor.....ea. .... 74.99
- GTBL-54 ...1953-54 Left Gas Tank Brace Under Trunk Floor .....ea. .... 74.99
- GTBR-54...1953-54 Right Gas Tank Brace Under Trunk Floor.....ea. .... 74.99

**1953-55 INSIDE REAR VIEW MIRROR**



- ISRVM-5355 ...1953-55 Chrome Day/Night Rear View Mirror.....ea. .... 49.99

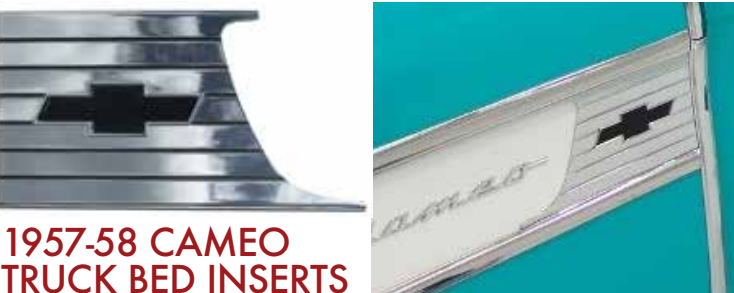

**1957-58 CAMEO TRUCK BED INSERTS**

Beautiful reproduction of a never before offered item! Originals are always pitted, stud pockets are often distorted & broken. Originals are almost impossible to restore & chrome plate. Ours are brand new precision manufactured alloy which is highly polished & then show chrome plated. Mounting studs & nuts included. Satin black bowtie & line details are finished! Manufactured in Sanford, FL USA.

- CTP-78 ..... 1957-58 Cameo Truck Bed Inserts.....pr ... 499.99
- C-SCRIPT78. 1957-58 Cameo Truck Chrome Bed Scripts .....pr ... 349.99

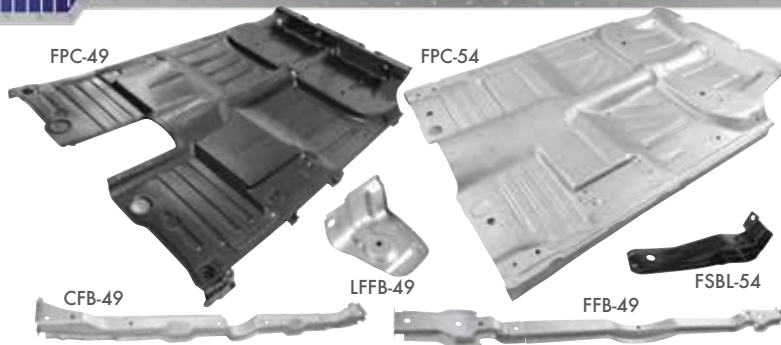

**1949-54 FLOOR PAN AND BRACES**

- FPC-49 ..... 1949-52 Complete Floor Pan\* ..... ea ... 1699.99
- FPC-54 ..... 1953-54 Complete Floor Pan\* ..... ea ... 1364.99
- LFFB-49 ..... 1949-52 Left Front Floor Brace ..... ea ..... 94.99
- RFFB-49..... 1949-52 Right Front Floor Brace..... ea ..... 94.99
- LFFB-54 ..... 1953-54 Left Front Floor Brace ..... ea ..... 94.99
- RFFB-54 ..... 1953-54 Right Front Floor Brace..... ea ..... 94.99
- FPBL-49 ..... 1949-52 Left Front Seat Brace Under Floor ..... ea ..... 74.99
- FPBR-49..... 1949-52 Right Front Seat Brace Under Floor..... ea ..... 74.99
- FSBL-54 ..... 1953-54 Left Front Seat Brace Under Floor ..... ea ..... 94.99
- FSBR-54..... 1953-54 Right Front Seat Brace Under Floor..... ea ..... 94.99
- CFB-49..... 1949-52 Center Long Floor Brace ..... ea ..... 189.99
- CFB-54..... 1953-54 Center Long Floor Brace ..... ea ..... 179.99
- FFB-49..... 1949-52 Forward Long Floor Brace ..... ea ..... 199.99
- FFB-53..... 1953-54 Forward Long Floor Brace ..... ea ..... 189.99
- RFB-49 ..... 1949-52 Long Rear Floor Brace.....ea ..... 199.99
- RFB-54 ..... 1953-54 Long Rear Floor Brace.....ea ..... 254.99
- TTC-49 ..... 1949-52 Transmission Tunnel inspection Cover..... ea ..... 104.99

**1949-54 TRUNK**

- TLS-4952..... 1949-52 Trunk Latch Bracket & Striker .. set.... 74.99
- SPW-49..... 1949-52 Spare Tire Well ..... ea .. 164.99
- TFB-49..... 1949-52 Trunk Floor Rear Crossmember Brace..... ea ... 129.99
- TFC-49 ..... 1949-52 Trunk Floor w/Braces & Spare Tire Well\* .. ea ... 839.99
- TFC-54 ..... 1953-54 Trunk Floor w/Braces & Spare Tire Well\* .. ea ... 899.99
- TFEL-49 ..... 1949 Left Trunk Floor Extension Panel ..... ea ..... 94.99
- TFER-49 ..... 1949-50 Right Trunk Floor Extension Panel..... ea..... 94.99
- TFRB-54..... 1953-54 Trunk Floor Rear Crossmember Brace..... ea ... 199.99



**1955-70 BRAKE HARDWARE**

- SAB-5558 ...1955-58 Self-Adjusting Drum Brake Hardware .....kit .... 79.99
- SAB-5970 ...1959-70 Self-Adjusting Drum Brake Hardware .....kit .... 79.99
- SABR-5558 . 1955-58 Rear Self-Adjusting Drum Brake Hardware..kit .... 49.99
- SABR-5970 . 1959-70 Rear Self Adjusting Drum Brake Hardware..kit .... 47.99

**1951-70 EMERGENCY BRAKE**

- EBK-5564 ... 1951-70 Car & 1951-70 Truck Rear Emergency Brake Shoe Levers ..set ... 74.99



CURRENT RESIDENT OR



### WHAT DO WE DO AT REAL DEAL STEEL?

A stroll through Real Deal Steel's Sanford, Florida USA plant will reveal active body assembly stations as well as our parts warehouse where we stock products for body assembly and parts for shipment to dealers and customers.

#### BODY ASSEMBLY

All of our complete body shells are officially licensed by General Motors (Chevy and Camaro). All RDS bodies are assembled using water-cooled automobile factory resistance spot welders just like GM used to assemble the originals. RDS received factory-direct training on the proper assembly procedures and techniques and participates in a continuing education program to keep abreast of all changes and improvements in the process.

All Real Deal Steel bodies are painstakingly test-fitted with doors and a trunk lid to be certain that all panels fit properly when the customer receives the order. In addition to fixturing, Real Deal Steel test fits the windshield and backglass (closed cars only) to make certain the end user will not have glass fitment issues. Additional fitting and bodywork (including seam filling) will be necessary by the end user but "moving metal around" will be unnecessary or minor at most.

**RDS ONLY** builds new bodies and supplies parts. We specialize in just these areas, ensuring the best results. We do not offer turn-key cars nor do we do any type of restoration work.

#### RESEARCH & DEVELOPMENT

RDS has designed countless products that you see for sale on our website & from other dealers. Over 100 of these items are proprietary to RDS. In addition, we have made (and continue to make) over 250 major & minor improvements in the quality of the sheet metal body parts that were already on the market for the 1955-57 Chevy cars but were made incorrectly or had severe fitment issues.

#### PARTS SALES

In addition to our proprietary products, RDS sells many other sheet metal and body related parts to our dealers and customers. This has developed simply due to demand from our dealers and repeat customers that don't wish to shop elsewhere.

# 2022 REAL DEAL STEEL CATALOG

STEEL BODIES BUILT BETTER. STEEL BODIES BUILT HERE IN THE USA.

REALDEALSTEEL.COM

407-585-1957